

Operating Instructions

Power-Charger

MODELS PC-300-303-304-305-306-307

Adjustment and Repair Information
Parts List

10c a copy

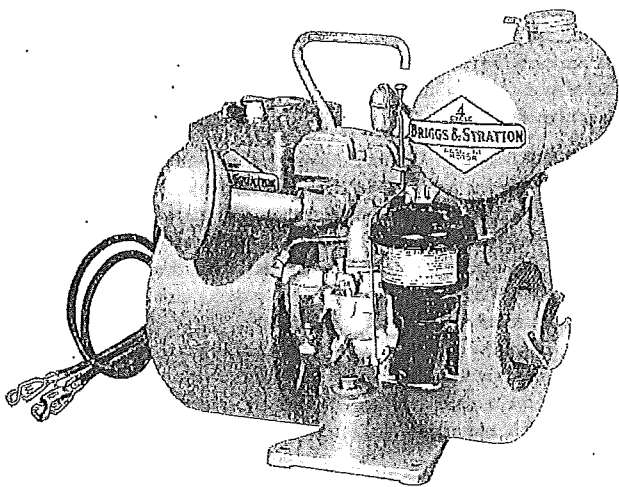

Read these instructions carefully before operating the Power-Charger for the first time.

Guessing how to run it may cause you unnecessary inconvenience, aggravation or failure to receive the fine service that is built into it.

There is a right way to operate the Power-Charger. This book tells you how.

Each Power-Charger is carefully tested and adjusted at the factory before packing for shipment, and if correctly operated will perform beyond your expectations.

DO NOT START THE POWER-CHARGER UNTIL YOU HAVE READ CAREFULLY "STARTING AND OPERATING THE POWER-CHARGER" ON PAGE 2

IMPORTANT

**ALWAYS USE GOOD, CLEAN OIL
S. A. E. No. 30**

For Temperatures Below 32° F. Use S. A. E. No. 10

**ADD OIL FREQUENTLY
CHANGE OIL REGULARLY**

INDEX

Page

SECTION ONE — OPERATING INFORMATION:

Starting and Operation.....	2
Storage Battery Information.....	4
Battery Radio Set Information.....	5
Power-Charger Location.....	5
Servicing Reference Chart.....	6
Instructions for Adjustment and Repair.....	6

SECTION TWO — GENERATOR:

Instructions for Adjustment and Repair.....	7
Control Box Instruments.....	8

SECTION THREE — GASOLINE MOTOR (MODEL "T"):

Instructions for Adjustment and Repair.....	10
Repair Parts.....	15
Motor Parts Illustrations.....	16
Motor Parts List.....	17-19
Generator Parts Illustrations.....	20
Generator Parts List.....	20
Nation-Wide Service Organization.....	21



IMPORTANT SAFETY INFORMATION AND INSTRUCTIONS FOR ENGINE SELECTION ENGINE INSTALLATION ENGINE OPERATION

In the USA and Canada,
our 24 hour hotline is:

18002333723

Briggs & Stratton Corporation
Milwaukee, Wisconsin 53201

www.briggsandstratton.com

Keep these instructions for future reference.





Before installing and operating this engine read and observe all warnings, cautions and instructions on both sides of this sheet, on the engine, and in the operating & maintenance instructions.

NOTE: This sheet of instructions and safety information is not meant to cover all possible conditions and situations that may occur. Read entire Operating & Maintenance Instructions for this engine AND the instructions for the equipment this engine powers. Failure to follow instructions and safety information could result in serious injury or death.

The safety alert symbol () is used to identify safety information about hazards that can result in personal injury.

A signal word (DANGER, WARNING, or CAUTION) is used with the alert symbol to indicate the likelihood and the potential severity of injury. In addition, a hazard symbol may be used to represent the type of hazard.

 **DANGER** indicates a hazard which, if not avoided, will result in death or serious injury.

 **WARNING** indicates a hazard which, if not avoided, could result in death or serious injury.

 **CAUTION** indicates a hazard which, if not avoided, might result in minor or moderate injury.

CAUTION, when used **without** the alert symbol, indicates a situation that **could result in damage to the engine.**

HAZARD SYMBOLS AND MEANINGS



Fire



Explosion



Moving Parts



Toxic Fumes



Hot Surface



Shock



Kickback

(OVER)

FORM MS-6445-01/03

ENGINE SELECTION



 WARNING



Failure to select the correct engine could result in fire or explosion.



- Some engines are unique and designed for specific applications or types of equipment. If this engine will be used to build new equipment, contact Briggs & Stratton to ensure that the engine is appropriate for the intended use.
Note: For all Go-karts use only a model 136200 series engine, which offers improved safety and performance.
- Replacement engines should be the same model as the original engine, or be the Briggs & Stratton designated replacement engine. Refer to the Operation & Maintenance Instructions for engine identification information.
Note: For all Go-karts use only a model 136200 series engine, which offers improved safety and performance.
- Do not use Briggs & Stratton engines on 3-wheel All-Terrain Vehicles (ATVs), motor bikes, air craft products, or vehicles intended for use in competitive events. Briggs & Stratton does not approve of or authorize such uses.

ENGINE INSTALLATION



- [1] Do not attempt to install this engine if you do not have the appropriate tools and knowledge of small engine installation procedures. Use only Briggs & Stratton parts. Contact your Authorized Service Dealer for assistance.
- [2] Do not modify the engine in any way without Briggs & Stratton factory approval. Any such modification is at the owner's sole risk.
- [3] If the exhaust system on the old engine was supplied by the equipment manufacturer, you must transfer the exhaust system and related components (original muffler and related pipes, brackets, clamps, and shields) to the new engine. All components must be in good condition.
- [4]



 WARNING	Install muffler (and muffler deflector if used) so outlet points away from operator, fuel tank, and equipment, and so muffler heat will not damage or deform engine and components.
	
- [5]



 WARNING	Ensure all fuel lines and fittings are properly assembled and do not leak. Replacement parts must be the same model as the original.
	
- [6]



 WARNING	Ensure all wiring, including safety switches and engine shut-off components are completely installed and functioning properly.
	
- [7] Set engine speed to equipment manufacturer's specification. Refer to equipment manufacturer's manual. Do not tamper with governor springs, or other parts that will increase engine speed above specification.

- [8]







 WARNING	All engine parts, including fuel cap, spark plug, muffler, air cleaner, and covers and guards for drive components (gears, belts, shafts, couplings, etc.) must be in place before attempting to start engine.
	
- [9]

 WARNING	If engine is installed on walk behind lawn mower, all mower components, including cutting blade, must be correctly installed before attempting to start engine.
	
- [10]

 WARNING	When working on the engine or equipment, remove spark plug wire from spark plug. For electric start, remove negative wire from battery.
	
- [11]

 WARNING	Do not check for spark with spark plug removed. Use Briggs & Stratton spark tester #19368.
	

ENGINE OPERATION

	 WARNING
	When adding fuel:
Turn engine off and let engine cool at least 2 minutes before removing gas cap. Fill fuel tank outdoors or in well-ventilated area. Fill tank to about 1 inch below lowest portion of neck to allow for fuel expansion. Keep gasoline away from sparks, open flames, pilot lights, heat, and other ignition sources.	
	 WARNING
	When starting engine:
Remove all external equipment/engine loads. Wait until spilled fuel is evaporated. Start engine outdoors. Pull cord slowly until resistance is felt, then pull rapidly. If engine floods, set choke to OPEN/RUN, place throttle in FAST and crank until engine starts.	
	 WARNING
	When operating equipment:
Do not tip engine or equipment at angle which causes gasoline to spill. Run engine outdoors. Do not run in enclosed area, even if doors or windows are open. Do not choke carburetor to stop engine.	

SECTION ONE

Starting and Operating the Power-Charger

	Paragraph		Paragraph
Power-Charger Location	2	Failure to Start Motor	10
Before Starting the Power-Charger	3	How to Stop	11
How to Connect Battery for Starting	5	Ammeter	12
Electric Starting — How to Start With a Battery	6	How to Operate as a Battery Charger	13
Manual Starting — How to Start Without a Battery	8	Charging Rate	16
		Correct Charging Rate	17
		How to Operate as a Lighting Plant	19
		12 Volt Lights	20

1. This Power-Charger is primarily a 300-watt, 12-volt charging plant. It can also be used to charge 6-volt storage batteries. A 12-volt battery or its equivalent should always be used between the Power-Charger and the 12-volt lighting circuit. The battery acts as a current reservoir for lighting purposes when the plant is not running. It provides current for electric starting of the plant and also serves to prevent the generator voltage from rising excessively with possible resultant damage to the generator.

2. **LOCATION.** You can run the Power-Charger just as soon as you have it unpacked and before you decide where it will be permanently located. Do not select the permanent location, however, until after you decide just what the Power-Charger is to do, and then only after you have carefully studied all of the instructions. It is not necessary to bolt it down for battery charging or lights, although a permanent and protected location is recommended.

3. **BEFORE STARTING THE POWER-CHARGER.** You can operate the Power-Charger as soon as you have it unpacked, after filling the crankcase with a high-grade S.A.E. No. 30 automobile oil, for operating in temperature of 32° F. and above. For operating in lower temperature, see paragraph No. 76, Page 10. **DO NOT USE ANY OIL HEAVIER THAN S.A.E. No. 30.** Crankcase holds 1 pint. Fill the gas tank with a good grade of clean, white, regular-test gasoline. Fuel tank holds two quarts.

4. **CAUTION.** Do not operate the Power-Charger at any time

without battery leads properly connected to a battery unless the control switch is set at "N" (neutral) immediately after starting.

5. **HOW TO CONNECT TO BATTERY FOR STARTING.** The Power-Charger can be started electrically when connected to either a 12-volt battery, or two 6-volt batteries connected in series. With the clamps provided, connect the battery leads, marked (+) and (-) on the control box, to the battery posts of the same markings. (See Plate No. 1.) As soon as the motor starts, generator charges battery according to switch setting. Connections to the battery must be clean and tight. For information on how to connect a 6-volt, or additional 12-volt batteries for charging, see paragraph No. 13 and plate No. 2.

6. **ELECTRIC STARTING.** To start, open gas shut-off valve on top of gasoline tank by turning to left. Completely close carburetor choke by turning lever in a clockwise direction, turn the control switch hard over against spring tension to "Start" position. The generator then acts as an electric starter and cranks the motor. When the motor fires, release the switch and it will automatically return to "N" (neutral) position. As the motor warms up, gradually adjust choke until motor is operating smoothly. Then set switch at desired charging rate. Operate carburetor choke the same as you operate the choke on your automobile. A hot motor does not require as much choking as a cold motor.

The Power-Charger — Plate No. 1

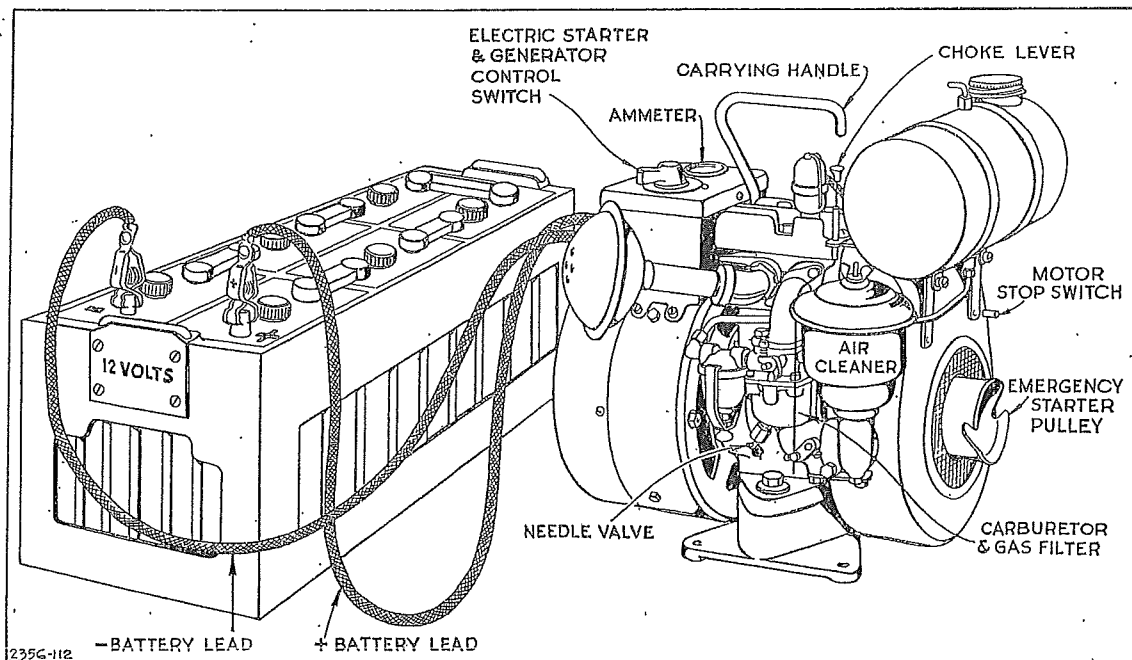

7. A low battery may sometimes fail to crank motor when turning the switch to "START." If this occurs, release switch for a few moments and then turn the switch back to "START." Do not hold the switch in "START" position over a few seconds at a time. If after operating switch in this manner a few times you are still unable to crank motor electrically, then crank motor with the emergency starter rope. See paragraphs 8 and 9.

8. **MANUAL STARTING—HOW TO START WITH A DEAD BATTERY.** The Briggs & Stratton motor has a built-in high tension magneto for ignition current and, therefore, the Power-Charger can be started even if the storage battery is dead. The battery provides a reservoir for lighting current and electric cranking power but does not supply any current for motor ignition.

9. To start motor manually, place switch at "N." Close carburetor choke by turning lever in a clockwise direction. Wind rope clockwise around starter pulley with knot on inside of slot. If Power-Charger is not bolted down hold it down by the carrying handle. Pull up quickly on starter rope. When motor starts, adjust choke until motor runs smoothly. Then set switch for desired charging rate.

10. **FAILURE TO START MOTOR.** If the motor fails to start after a reasonable number of trials, either by cranking electrically or by rope, do not make any adjustments until you have studied instructions on the Model "I" motor. See page No. 10.

11. **HOW TO STOP.** Press the stop switch mounted on the cylinder head against the end of the spark plug. Hold it until motor stops firing. This will ground the spark. To stop models equipped with ignition shielding, push the red stop pin, located on the blower case below gasoline tank.

12. **AMMETER.** The Ammeter indicates the generator performance and is mounted on the control box cover. If control switch is at "START" or "N," the needle remains at zero (0) on the dial. If the needle remains at zero with the switch set at "LOW" or "HIGH," check to see that connections to the battery are tight

and clean. If needle still remains at zero, see Control Instructions, paragraph 66.

13. **HOW TO CHARGE BATTERIES.** If you wish to charge other than the 12-volt battery regularly connected to the plant, start the motor either electrically with the regular battery or manually with the rope. Set switch at "N" (neutral).

14. The generator armature of the Power-Charger Model 302 is wound for maximum efficiency at 12 volts, 300 watts, and therefore it is desirable to hook up the batteries on a 12-volt circuit. Hook-ups of circuits less than 12 volts can be made but will reduce the watt output. If more than one 12-volt battery is to be charged the batteries must be connected in parallel. (See plate No. 2 for suggested battery hook-ups.)

15. Due to varying conditions of batteries, the charging current may not divide equally between the batteries on a parallel hook-up and as a result the batteries may not finish charging at the same time. Therefore the individual cells should be carefully watched for completion of charge. If the hydrometer test shows one battery approaching completion of the charge before the other, it should be disconnected. After the other battery approaches its completion of charge, again connect the two batteries and finish charging with the switch set at "LOW."

16. **CHARGING RATE.** The proper charging rate can be obtained by operating motor at 2900 R.P.M. Higher generator output should not be attempted by increasing motor speed above 2900 R.P.M. See paragraph 54.

17. **CORRECT CHARGING RATE.** The Power-Charger switch control provides two steps of generator output—a "HIGH" which is the full capacity of the plant and a "LOW" or finish rate. The reason for this is to conserve battery life. It is a known fact that batteries continually charged at a high rate heat excessively which causes rapid wear of plates and separators. In fact, such continued abuse will cut battery life from one-third to one-half. The high rate is very desirable up to the time the battery starts to boil and gas, which is when the temperature of the solution reaches approximately 110° F. At this time the output should be reduced by setting the switch at "LOW." The point at which the battery will heat depends upon its condition, size and rate of charge. Add distilled water before charging and check during the charging to see that plates are covered—especially if charging at high rate.

18. After the battery has been charged and the plant stopped, it is not necessary to disconnect battery leads from the battery. Under this condition no current can leave the battery through the Power-Charger because an automatic circuit breaker is installed in the control box—this automatically breaks the battery circuit. If additional batteries are to be charged, motor can be left running but switch should be set at "N" (neutral) before making change.

19. **TO OPERATE AS A LIGHTING PLANT.** All current for light should be taken from a battery, or batteries. Do not connect Power-Charger direct to lighting wires. A battery must always be in the line, even though the battery is run down. You can always bring up the battery voltage and have lights by starting up the Power-Charger as long as your light load is not over 300 watts. If the load is less than 300 watts, the difference goes into the battery as a charge.

20. **12-VOLT LIGHTS.** All current for lights should be taken from a battery. The battery should be as large as possible. Any number of lamps can be in lighting circuit, except that the current used by all lamps burning at one time should not exceed a total of 300 watts.

21. The permanent location for the lighting battery should be where it can be easily connected to the Power-Charger any time, so that even though the battery runs down you can still have lights by starting up the Power-Charger. (See paragraph No. 41.)

Battery Charging Hook-Up—Plate No. 2

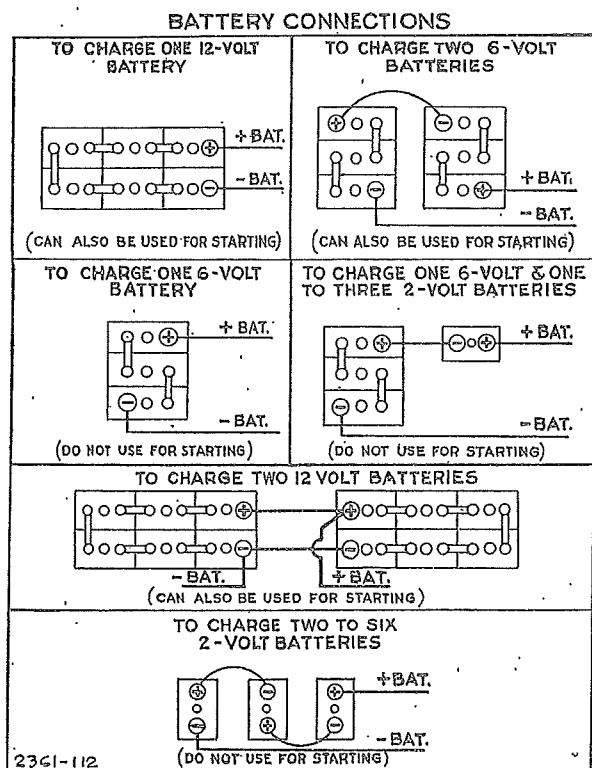

Storage Battery Information

	Paragraph		Paragraph
Care of Battery.....	22	Battery Leads	29
Size of Battery.....	25	Connecting the Battery to Power-Charger...	30
Number of Batteries.....	26	To Determine the Charge in a Battery.....	32
Battery Location	27	Charging the Battery.....	35

22. CARE OF THE BATTERY. Most important in the care of a battery is to keep it clean, filled, and well charged. Clean the corrosion from the terminals frequently and oil or grease them to prevent corrosion. By adding distilled water keep the solution about 1/2" above the plates at all times. Check solution level before and after charging.

23. The solution in a battery is sulphuric acid and distilled water. The water gradually evaporates in use and should be replaced with pure distilled water or filtered rain water. Never use anything else. Use a hydrometer to add water. Do not over-fill cells or solution may bubble over. Acid should never be put into a battery unless the solution is accidentally spilled. In such an emergency, fill with electrolyte solution.

24. CAUTION: Do not spill battery solution on clothes, furniture, etc., or permit it to come in contact with the skin. It is a dangerous acid.

25. SIZE OF THE BATTERY. It never pays to buy too small a battery. The additional amount spent for a larger battery will be offset in less frequent charging, lower operating costs and will result in greater satisfaction. Buy the largest size battery you can for the work you want it to do. The life of a battery is determined by the number of charges and discharges it receives.

26. NUMBER OF BATTERIES. The number of batteries you need can be determined only after you have decided where you want light and how much light you require.

27. LOCATION. Never locate a battery near a stove or furnace, as the heat will rapidly evaporate the water. Neither should a battery be left in a room subject to extreme cold, as it will freeze and break if left in a discharged condition.

Always place batteries, as shown in plate No. 1, at generator end of "Power-Charger." Do not place them at the back of the motor near breather. The fumes of the battery may enter crankcase of motor through breather, causing a chemical reaction in the oil, with resultant damage to the bearing surfaces within the motor.

28. Select a location for each battery as near to the center of the load it has to carry and as near to the Power-Charger as possible. If the main battery can be permanently connected to the Power-Charger, so much the better. Other smaller batteries can easily be taken to it for charging separately or in parallel with the main battery.

29. BATTERY LEADS. The leads furnished with the Power-Charger are of convenient size and length for average use. In some instances it might be desirable to extend these leads a few feet to make a convenient and permanent installation. For the minimum amount of current loss these extensions should be of length and size of wire as follows:

- 3 feet — use No. 6 cable
- 6 feet — use No. 4 cable

Do not exceed these lengths or use smaller wire from the Power-Charger to the battery, or line loss will affect electric cranking power.

30. CONNECTING THE BATTERY TO POWER-CHARGER. Use care in properly connecting the (+) and (-) battery terminals to battery leads and jumpers. A battery can be ruined or the Power-Charger damaged if these connections are not as shown. All connections must be clean and tight. If Power-Charger is running, do not make or change connections without putting control switch in "N" position.

31. One or more 6-volt batteries can be connected in series and charged at the same time. 2-volt batteries should be charged only in series of not less than three. (See plate No. 2.)

32. TO DETERMINE THE CHARGE IN A BATTERY. Use a battery type hydrometer and test all cells in the battery occasionally to determine their condition. Most hydrometers are clearly marked "discharged," "half" or "fully charged" and are usually graduated in figures. 1150 shows a discharged battery, while all cells of a fully charged will read 1275 to 1285.

33. Do not wait until a battery is completely discharged before recharging it. Check it occasionally with a hydrometer. You will soon learn by experience how often it will need recharging. The dimming of lights or poor radio reception are sure signs of a low battery.

34. You cannot use an ammeter to determine the charge in a storage battery. The high momentary discharge will destroy the ammeter.

35. CHARGING THE BATTERY. The Power-Charger controls provide two steps of generator output—a "LOW" or finish rate, and a "HIGH," the full capacity of the plant. The reason for this is to conserve battery life. It is a known fact that batteries continually charged at a high rate develop excessive heat which causes rapid wear of plates and separators. In fact, such continued abuse will cut battery life from one-third to one-half. The high rate is very desirable up to the time the battery starts to boil and gas, which is when the temperature of the solution reaches approximately 110° F. At this time the output should be reduced by setting switch at "LOW." The point at which the battery will heat depends upon its condition, size and rate of charge. Also see paragraph 37.

36. Unless the battery to be charged is discharged, connect it to the Power-Charger and use it to crank the motor electrically. See paragraph 5. Add distilled water to bring up the level in all cells. After the motor warms up, put control switch at "HIGH." When battery cells start to boil or gas, reduce charging rate by turning switch to "LOW." When battery tests 1275 to 1285, it is fully charged. Again check solution level.

37. It is not always convenient to watch battery while it is charging to determine when to change charging rate to "LOW" or when to stop charging. Experience will soon teach you how much gasoline to put in the tank to run the Power-Charger for about the correct length of time according to the condition of the battery. When the motor runs out of gasoline it will stop. It will not be necessary to do anything to the plant or battery until you are ready to start it up again, because the automatic circuit breaker breaks the battery circuit when charging stops.

Battery Radio Set Information

38. **GENERAL RECOMMENDATIONS.** Most modern types of battery radios use either a 6-volt or a 2-volt wet storage battery. The Power-Charger can be used to charge either types of batteries. When charging 2-volt batteries only, be sure to hook-up in series of not less than three batteries. A single 2-volt battery may also be charged in series with a 6-volt battery. See plate No. 2.

39. The radio should be provided with an individual battery

located as near the radio as possible. Follow the radio manufacturer's instructions. When it needs recharging it should be disconnected and removed entirely from the radio.

40. **CAUTION:** Never change the radio battery while the radio is in operation. During the charging period the voltage rises approximately 25% which is sufficient to burn out or greatly shorten the life of the tubes.

Where to Permanently Install the Power-Charger

	Paragraph
Location	41
Exhaust Gases Are Poisonous.....	42
Pipe Exhaust Gases Away.....	43

	Paragraph
Exhaust Muffler	45
Boat and Trailer Installations.....	46

41. **LOCATION.** The Power-Charger should be located where it will be dry, protected from the weather, and convenient to the work it is to do. It is not necessary to bolt the plant down. It should, of course, be located as near as possible to your main battery.

42. **EXHAUST GASES ARE POISONOUS.** Never operate the Power-Charger in any room without conducting the exhaust gases outside and to such a point that they will not be carried back into the rooms by air currents through windows or doors. The exhaust fumes from all gasoline motors are poisonous.

43. **PIPE EXHAUST GASES AWAY.** Exhaust fumes should be piped to the outside. We recommend the use of flexible exhaust tubing of 1" diameter. The fittings necessary are: 1/2"x4" standard pipe nipple, 1/2"x3/4" reducer coupling, 3/4"x2" standard pipe nipple and 1" flexible tubing not to exceed 10 feet. The

flexible tubing must be tightly screwed onto the 3/4" nipple. See Fig. 1, plate No. 3 for proper assembly. If 7/8" flexible tubing is obtainable it can be brazed directly to the 1/2" nipple.

44. For permanent installation a 3/4" iron pipe may be used in place of flexible tubing. This installation calls for the same fittings listed in paragraph 43, inserting a short piece of 1" flexible tubing between the 3/4" nipple and the 3/4" pipe to relieve the strain on the exhaust port. Also use a standard 3/4" elbow and a strap to support the pipe. A tee fitting with a drain plug should be used in the exhaust line at the lowest point to drain out the water which collects from condensation. (See Fig. 2, plate No. 3.)

45. **EXHAUST MUFFLER.** The muffler furnished with the motor is adequate for most purposes. It can be unscrewed from the exhaust fitting and attached to the end of the exhaust tube or pipe. The exhaust may also be conducted into a barrel or box buried in the ground outside the building and filled with rocks. Practically all the exhaust noise will thus be eliminated.

46. **BOAT AND TRAILER INSTALLATIONS.** The Power-Charger with its small size, compactness, light weight, and 300-watt capacity is ideal for installation in trailers and small cabin boats. No. 8 wire should be used for full efficiency of the lamps.

47. The Power-Charger may be located in a protected spot and the exhaust conducted outside the trailer or boat. Asbestos sheathing should be wrapped around the exhaust tubing or pipe to prevent burning of material it may contact.

48. In trailer installations, it may be desirable not to install the Power-Charger permanently, but to carry it in a storage space within the trailer and set it outside while it is being operated. Trailers with built-in trunks may have the battery and Power-Charger mounted permanently in that compartment, but it is very essential that the trunk compartment door be left open while the Power-Charger motor is running to insure an adequate supply of cool air to the motor. This is essential, as the motor, being of the air-cooled type, depends entirely for its cooling on an unrestricted flow of air. If the compartment is closed, over-heating will result in damage to the motor.

Exhaust Pipe Installation
Plate No. 3

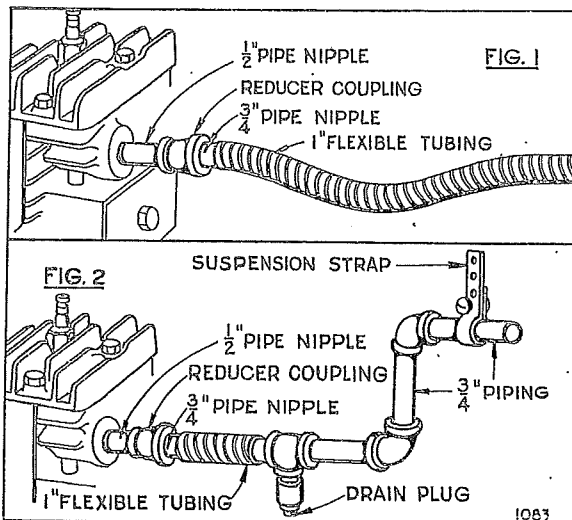

Servicing Reference Chart

	Paragraph		Paragraph
MOTOR FAILS TO START		MOTOR OVERHEATS	
Out of Gasoline.....	3-80-81	Lack of Oil.....	3-77-120
Out of Oil.....	3-77-120	Oil Needs Changing.....	78
Poor Connections to Battery.....	4-5-8	Oil Too Heavy.....	3-77
Water in Cylinder.....	44	Carburetor Out of Adjustment.....	86-88
Generator Trouble.....	56 to 70	Poor Spark.....	92-104
Dirt or Gum in Fuel System.....	80 to 83	Carbon.....	118
Incorrect Use of Choke.....	84	Motor Overloaded.....	121
Carburetor Out of Adjustment.....	86-87	MOTOR DOES NOT HAVE POWER ENOUGH	
Spark Plug Dirty.....	94	Lack of Oil.....	3-77-120
Ignition Cable Grounded.....	95	Add or Change Oil.....	77 to 79
Magneto.....	98 to 106	Carburetor Out of Adjustment.....	86-87
Poor Compression.....	106	Motor Not Up to Speed.....	88-89
Motor Overloaded.....	121	Motor Overloaded.....	121
MOTOR STOPS		Poor Spark.....	92 to 104
Out of Gasoline.....	3-80-81	Carbon.....	118
Out of Oil.....	3-77-120	Muffler Clogged.....	119
Dirt or Gum in Fuel System.....	80 to 83	Exhaust Pipe Too Long.....	43
Motor Overheated.....	3-76 to 83-120	GENERATOR DOES NOT FUNCTION PROPERLY	
Motor Overloaded.....	121	Poor Connections to Battery.....	4-5-13-22-30
MOTOR STOPS		Battery Leads Too Long.....	29
Out of Gasoline.....	3-80-81	Brushes Worn.....	56
Out of Oil.....	3-77-120	Dirty Commutator.....	58
Dirt or Gum in Fuel System.....	80 to 83	Generator Inoperative.....	54-69
Motor Overheated.....	3-76 to 83-120		
Motor Overloaded.....	121		

Instructions for Adjustment and Repair

49. **GENERAL DATA.** You will find the Briggs & Stratton Power-Charger substantially built, of high grade materials, by skilled workmen. The factory is fully equipped with the most modern machinery. Before it was shipped the Power-Charger was in first class operating condition, after many tests and careful inspections.

50. The less you tinker with your Power-Charger the better service it will give you. This does not mean, however, that it does not require a certain amount of attention, for it is only a machine. It cannot tell you its wants. Give it the right kind of fuel, oil, and care. Keep it clean both inside and out. You will be well repaid in trouble-free, satisfactory service.

51. If you should experience any difficulty, follow the instructions

referred to in the SERVICING REFERENCE CHART above.

52. Then if you cannot easily remedy it, consult a nearby Authorized Briggs & Stratton Central Service Distributor.

53. The Power-Charger is comprised of three separate units. (1) the drive, instruments, wiring and base; (2) the generator, and (3) the gasoline motor. The generator and motor units can easily be removed and serviced independently of each other. Servicing instructions for each of the main units are divided as follows:

Section One—Operating Information, page 2.

Section Two—Generator and Instruments, page 7.

Section Three—Briggs & Stratton Gasoline Motor, page 10.

SECTION TWO

Generator

Instructions for Adjustment and Repair

	Paragraph		Paragraph
General Data	54	To Remove and Replace Armature.....	61
Brushes	56	To Test Field Coil.....	62
To Install or Reseat Brushes.....	57	To Test Armature.....	63
Commutator	58	Parts	64
To Remove Generator from Motor.....	60		

54. GENERAL DATA. The special high efficiency 4-pole, four-brush shunt wound, air-cooled generator has a maximum rated hot output at 15 volts of 21 to 23 amperes at 2750 to 2900 R.P.M.—the output rating taken at the battery terminal of relay. The generator output is controlled by speed and connected load, but the 2900 R.P.M. speed must not be exceeded in an attempt to gain a higher generator output than listed above.

55. The following instructions are given to assist the owner who is not conveniently located to either authorized Briggs & Stratton service facilities or the factory.

56. BRUSHES. The special size brushes are mounted in box type brush holders riveted to the brush plate assembly. The brushes should be inspected occasionally for brush wear. This can be done by removing the generator cover and pulling out the "U" shaped staples. See plate No. 4. Brushes that are worn to within 1/4" of the holder should be replaced.

Brush and Commutator Assembly.—Plate No. 4

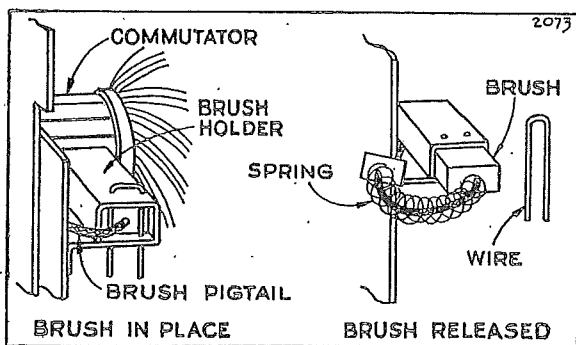

57. TO INSTALL OR RESEAT BRUSHES. To replace the brushes, loosen screw on the brush plate holder which holds the brush pig-tail. Replace brush and tighten screw. To seat brushes, wrap a strip of No. 00 sandpaper around the commutator with the rough side next to brushes. A few strokes with the sandpaper will form the brush seat correctly. Remove sandpaper and blow out all sand dust. NEVER USE EMERY CLOTH TO SEAT BRUSHES. See plate No. 4.

58. COMMUTATOR. If inspection shows the commutator to be black or dirty, it can be polished and cleaned by holding a piece of No. 00 sandpaper against it while the unit is running. This can best be done by placing the sandpaper over the end of a stick, cut square on the end. Have both the stick and sandpaper trimmed just the width of the commutator. Do not use excessive pressure on commutator. If inspection of the commutator shows it to be worn rough or the copper bars worn even with the mica insulation between the bars, the unit should be dismantled, thor-

oughly cleaned, the commutator turned in a lathe, the insulation undercut, and the unit reassembled.

59. FAILURE TO CRANK MOTOR. If the motor generator fails to crank the motor with switch at "START," check the battery terminals to battery lead connections. These must be clean and tight. Then check the battery to be sure it is at least half charged. If battery is up, check switch as follows: Disconnect battery, open control box cover and without disconnecting any wires attach a

Switch Test Bridge Connection
Plate No. 5

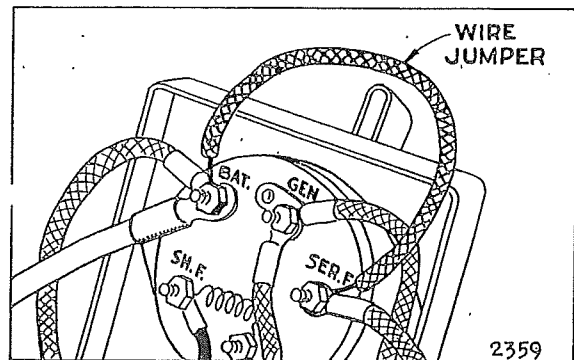

piece of heavy insulated wire across the "Bat." and "Ser. F." terminals of the switch. See plate No. 5. Reconnect the battery and if the unit operates as a starter, switch trouble is indicated. If these tests do not locate the trouble and inspection of the brushes shows they are in good condition and properly fitted to the commutator and the commutator is clean, it is probable that the trouble is in the motor-generator unit. If the ammeter shows full discharge and the engine fails to start, the battery may be too low. In this case it is sometimes helpful to turn the engine by hand just over the compression stroke. If it then does not start, use rope and start by hand.

60. TO REMOVE GENERATOR FROM MOTOR. The generator is mounted on a tapered extension of the motor crankshaft. To remove the generator from the motor, first remove generator end cover held in place by four screws. Then remove the bolt and lockwasher holding the generator fan on the crankshaft. Remove fan. Remove generator shell from motor mounting bracket by removing four bolts and lockwashers located on the mounting bracket behind the generator. If it is necessary to remove brushes or brush holder bracket, it can be done easily by removing four screws and lockwashers.

61. TO REMOVE ARMATURE. After having followed the instructions in the preceding paragraph, the armature is exposed and can easily be removed. If it is tight on the crankshaft taper,

tap it lightly on the laminations with a wood or lead hammer to loosen it or insert a brass rod in hole of rotor shaft against the motor, take off shaft and hit with a sharp rap. To reassemble, reverse the operations performed above. Be sure the bolt and lockwasher holding the fan are tight—because this bolt also holds the generator armature in place. Likewise the four bolts holding the generator shell to the mounting bracket must be tight.

62. FIELD COIL TESTS. Do not make this test unless you are familiar with electrical work. There are two field windings—a heavy series winding and a light shunt winding. To test these for grounds, connect one end of heavy field to one battery terminal and touch metal field frame with lead from the other battery terminal. If no spark, field is not grounded. Make the same

test on the shunt field. To test for open field, connect field with a voltmeter and battery in series. If no voltage is shown on voltmeter, the field winding is open. If field is not open, the voltmeter will show battery voltage.

63. TO TEST ARMATURE. Disconnect the grounded brush from frame. Disconnect insulated brush from field. Connect one battery terminal with lead to pig-tail on insulated brush and touch other end of battery to frame. Connect a voltmeter and battery in series. A reading on voltmeter will show a grounded armature. If there is no reading, the armature is not grounded.

64. PARTS. All generator parts should be ordered from Briggs & Stratton Corp. or nearest Authorized Briggs & Stratton Service Distributor listed on page 21. For parts and illustrations, see page 20.

Control Instruments

	Paragraph		Paragraph
Control Box Wiring.....	65	Generator Output Too Low or No Output..	68
Ammeter	66	Wiring Diagram	69
Automatic Circuit Breaker.....	67		

65. CONTROL BOX WIRING. The control box houses the multiple control switch, ammeter, automatic circuit breaker and all wiring. If for any reason the wiring needs to be inspected, loosen cover which is held on by 4 screws, push the battery lead wires into the box from the outside to give it slack. All connections are clearly shown in plate 6.

66. AMMETER. If ammeter does not show "CHARGE" with switch at "HIGH" or "LOW" it may be due to—

1. Poor connections.
2. Wrong or defective wiring.
3. Dead battery cell.
4. Generator brushes worn, dirty or not making contact.
5. Dirty or worn commutator.
6. Generator has open field circuit.
7. Generator armature burned out.
8. Motor not up to speed. (Motor speed 2750 to 2900 R.P.M.)
9. Defective switch.
10. Defective circuit breaker.
11. Defective ammeter.

Control Box Wiring—Plate No. 6

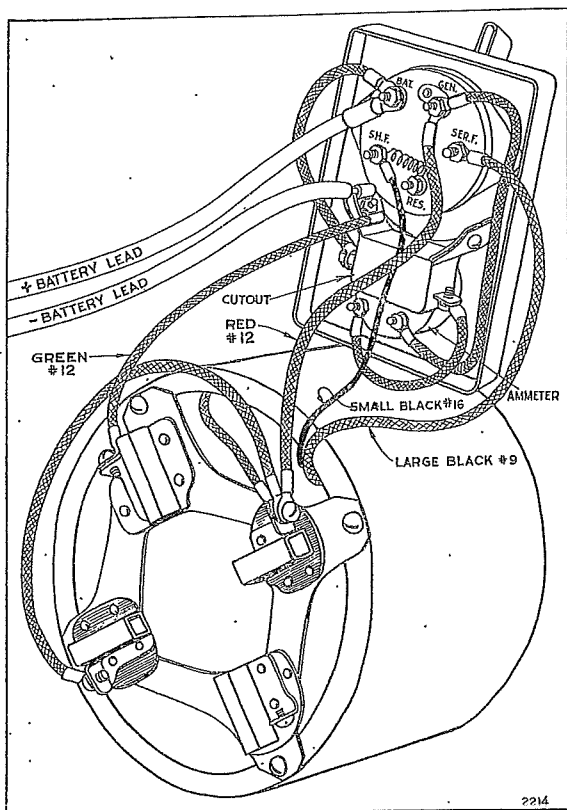

(a) To locate trouble, stop Power-Charger with stop switch and proceed as follows: turn control switch to "START" and if gasoline motor is cranked electrically, numbers 1 to 7 inclusive are O.K. If not O.K., check connections, wiring (see plates 6 and 7), battery, generator brushes (see paragraphs 56 and 57), generator commutator (see paragraph 58), generator circuits (see paragraph 62) and switch (see paragraph 59). (b) After motor starts and has warmed up place switch at "HIGH," and if ammeter still does not show "CHARGE" continue checking the following points: (c) Be sure motor and generator are up to speed. (d) Next open control cover (see paragraph 65). (e) Check switch by placing a wire jumper across terminals of switch marked "GEN" and "SH.F." without disconnecting any wiring and if ammeter shows charge it indicates that portion of switch is defective. (f) If ammeter does not show charge, check the circuit breaker (see paragraph 65). If circuit breaker is O.K. then ammeter itself is defective. NOTE: Ammeter is designed as a generator output and discharge indicator only. If ammeter shows charge, when gen-

erator is charging (with switch at either "HIGH" or "LOW"), the needle does not necessarily indicate the amount of current put out by the generator, but only that the generator is charging. If ammeter shows discharge, automatic circuit breaker points may be stuck (see paragraph 67), or battery leads are not connected to the proper battery terminals—they must be (+) to (+) and (-) to (-).

67. CIRCUIT BREAKER. This instrument is located in the control box. Its purpose is to protect the battery against discharge back through the generator. If for any reason the generator stops charging the circuit breaker automatically breaks the circuit. If ammeter does not indicate "CHARGE" with switch at "HIGH" it may be the result of either a defective circuit breaker, loose resistor connections, dirty circuit breaker points or the circuit breaker points do not close. The latter is caused by too much tension on contact arm spring and can be remedied by decreasing the tension. We suggest that adjustment of spring tension be done by a mechanic familiar with circuit breakers because improper adjustment may result in damage. If the wiring becomes hot when the generator is not running, or there is other evidence of a short in the control box, ammeter will show "DISCHARGE." Remove the cover from the control box and also from circuit breaker and examine the contact points. If they are burned or stuck, separate them and clean them with fine sandpaper. This may be caused by too little tension of the spring connected to the contact arm. Increase tension by bending the small metal clip, to which one end of the spring is attached.

68. GENERATOR OUTPUT TOO LOW OR NO OUTPUT. This condition may be due to a low motor speed or defects in generator, instruments or wiring (see paragraph 66). Also, the brushes may be worn or not seating properly (see paragraphs 56 and 57), or generator commutator may be dirty (see paragraph 58).

69. COMPLETE WIRING DIAGRAM. The complete wiring diagram of the generator, multiple control switch, circuit breaker, ammeter, voltage regulator and leads to battery are shown in plate No. 7.

70. PARTS. All parts should be ordered from your dealer or nearest Authorized Central Service Distributor (see page 21). For parts list and illustrations see page 20.

Complete Wiring Diagram—Plate No. 7

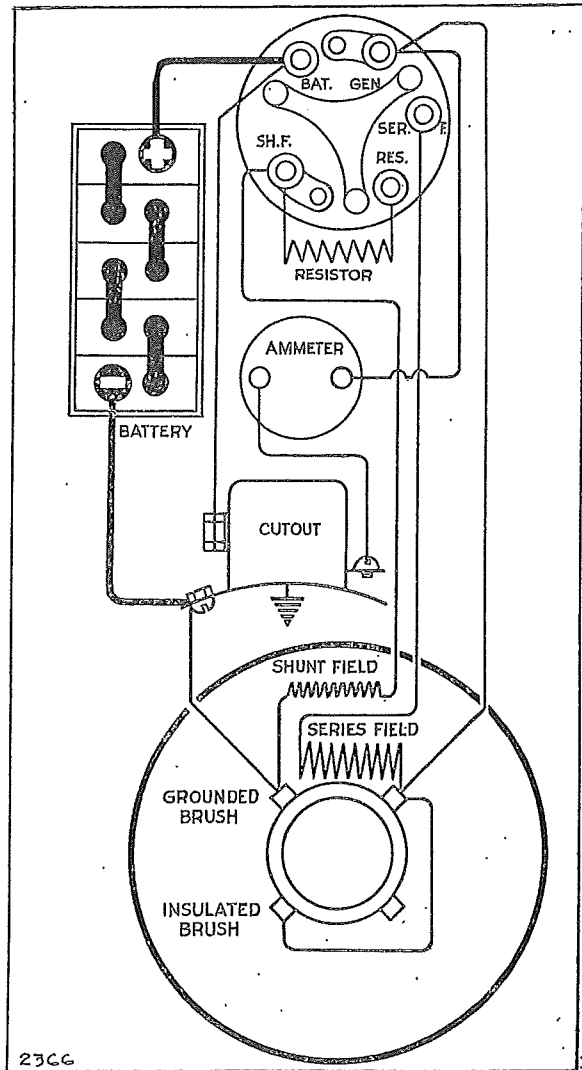

SECTION THREE

Briggs & Stratton Gasoline Motor (Model "I")

Instructions for Adjustment and Repair

	Paragraph		Paragraph
Operating Requirements	71	To Remove and Replace Magneto.....	98
How a 4-Cycle Motor Works.....	73	Magneto Timing	99
Keep the Motor Clean.....	74	To Adjust and Clean Contact Points.....	100
Use the Right Kind of Oil.....	76	To Replace Condenser.....	101
Add Oil Regularly.....	77	To Replace and Adjust Armature.....	103
Change Oil Frequently.....	78	Cylinder Head	105
Use Clean Gasoline.....	80	Compression	106
Avoid Gummy Gasoline.....	81	Valve Adjustment	107
To Clean the Fuel Lines.....	83	Piston	112
Correct Use of the Choke.....	84	Piston Rings	114
To Prime the Motor.....	85	Piston Pin	115
To Adjust the Carburetor.....	86	Connecting Rod	116
To Remove and Replace Carburetor.....	88	Oil Pump	117
To Clean Carburetor.....	89	Oil Leaks	120
Governor—Correct Motor Speed.....	90	Carbon	118
The Ignition System.....	92	Muffler	119
To Check for Spark.....	93	Exhaust Tubing	43-44-45
Spark Plug Adjustment.....	94	Overload	121
Ignition Cable	95	Parts	122
To Remove and Replace Flywheel.....	96		

71. OPERATING REQUIREMENTS. A gasoline motor to operate properly must have all parts in correct adjustment to provide good ignition, carburetion, compression and cooling. And of equal importance, the oil and gasoline used must be clean and of the recommended grades. The following instructions fully explain the simple adjustments and offer operating recommendations that will assure you complete satisfaction. We urge you to carefully observe them.

72. The reliability, economy and ease of starting which characterize this motor are due in part to the fact that it is of the 4-stroke cycle design commonly called "4-cycle," the same design used in all automotive motors. As the name indicates there are four strokes to one complete power cycle.

The 4-Stroke Cycle
Plate No. 8

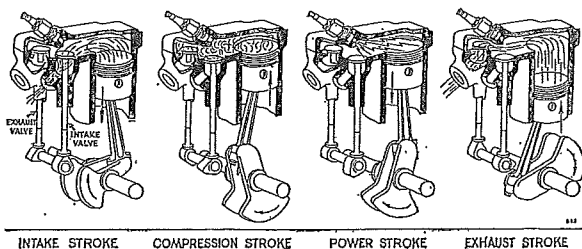

73. HOW A 4-CYCLE MOTOR OPERATES. On the intake stroke the piston goes down, producing a vacuum in the cylinder, thereby drawing fuel up through the carburetor so that the space above the piston becomes filled with combustible gas. During this stroke the intake valve is open. Next the piston comes up on the compression stroke with both valves closed. At the top of

the compression stroke a spark occurs at the spark plug, firing the highly compressed gas. This produces an explosion above the piston which forces it down on the power stroke. Both valves are closed. On the next upstroke of the piston, called the exhaust stroke, the exhaust valve is open, and the burned gases driven out. See plate No. 8.

74. KEEP THE MOTOR CLEAN. It will pay you to keep your motor clean both inside and outside. See that no dirt or water enters motor when filling with oil or gasoline. As a precautionary measure always wipe off the gasoline cap and oil filler plug, as well as around them before refilling. Dirt in the motor or gasoline tank will cause trouble and even serious damage.

75. OIL BATH AIR CLEANER. The air cleaner is to protect the motor from dust and dirt. No motor can stand up under the grinding action that takes place when dust and dirt particles are drawn into the motor through the carburetor. Remove the air cleaner from the carburetor, drain the old oil and refill with a light engine oil. The air cleaner should be cleaned frequently or, if necessary, daily, if there is a lot of dust and dirt. Test the air cleaner to see if it is clogged by blowing through it or noting if motor performs better with it off. If clogged, the filter should be replaced. **KEEP OIL LEVEL UP TO THE BEADING.** Read the instructions on the label.

76. USE THE RIGHT KIND OF OIL. Correct lubrication is important. We recommend the use of Mobiloil Arctic S.A.E. No. 30 for operating this motor in temperatures of 32° F. or above. For temperatures below 32° F. use Mobiloil Arctic Special or other high grade oil not heavier than S.A.E. No. 10. Do not mix oil with gasoline. This 4-cycle motor is provided with an independent efficient pump lubrication system which forces a stream of oil to all moving parts of the motor. There are no external parts which require separate oiling.

77. ADD OIL REGULARLY. A motor which is run without oil will be ruined within a few minutes. To avoid the possibility of such an occurrence and the resulting expense, always fill the oil reservoir at the blue plug to the top of the filler plug opening after each five hours of motor operation. Capacity of oil reservoir is 1 pint.

78. CHANGE OIL FREQUENTLY. After every twenty-five hours of motor operation, the oil should be completely drained from the crankcase. Do not remove motor from its mounting base. Remove the drain plug located in end of base. We do not recommend flushing out with kerosene. Replace the drain plug, refill with fresh oil and replace the blue filler plug.

79. In the normal running of any motor, small particles of metal from the cylinder walls, pistons and bearings will gradually work into the oil. Dust particles from the air also get into the oil. Sludge, a gummy mass, forms which clogs up the oil passages. If the oil is not changed regularly, these foreign particles cause increased friction and a grinding action which shortens the life of the motor. Fresh oil also assists in cooling, for old oil gradually becomes thick and loses its cooling as well as its lubricating qualities.

80. USE CLEAN GASOLINE. A good grade of clean, fresh, regular gasoline is recommended. Too high test gasoline may form vapor-lock in gas line when motor gets hot. This interrupts the flow of gasoline and causes motor to stop. Be sure that the small vent hole in the gasoline tank cap is not clogged up, for air must enter the tank to allow the gasoline to flow to the carburetor. Test by blowing through top of cap.

81. AVOID GUMMY GASOLINE. If you experience trouble with a gummy, sticky substance with a peculiar sharp obnoxious smell, change to another grade of gasoline. This gum comes from the gasoline and clogs carburetor, gas line, gasoline tank, check valve, etc. You can check your gasoline by evaporating a half pint in an open dish. If a quantity of gum remains, try another kind that is clean and fresh.

82. You can avoid most trouble from gum if you will keep the tank full when you are not using the motor. If you use it only occasionally, drain tank completely and refill when motor is used again. The reason for this is that evaporation of stale gasoline causes most gum deposits.

83. TO CLEAN THE FUEL LINES. Close the gas shut-off valve on top of gas tank, turn valve to right. Disconnect gas line at gas filter and also at the gas tank. Blow through the gas line to clear it. To clean the gas filter, remove cover from carburetor bowl. Loosen thumb screw below gas filter bowl. Remove and clean filter bowl and screen. Blow through the gas passage in the cover between carburetor and gas filter bowl. **IMPORTANT:** If you find a gummy, varnish-like substance use alcohol or acetone to dissolve it. See paragraphs 81 and 82.

84. CORRECT USE OF THE CHOKE. The correct carburetor setting (see paragraph 87) gives the motor the best mixture to run on when it is hot. For starting, it is necessary to choke the carburetor to get a rich mixture, because cold gasoline does not vaporize readily. A warm or hot motor requires very little choking. Until you become familiar with your motor, however, you may make the mistake of not choking the carburetor enough or you may choke it too much. If motor fails to start after cranking three or four times with the choke closed, try cranking two or three times with the choke part way open and then all the way open. Use motor choke the same as you use an automobile choke.

85. TO PRIME THE MOTOR. The motor may fail to start for the reason that either the carburetor is incorrectly adjusted or dirty,

or the fuel line or gas filter is dirty or clogged, or you are out of gasoline. To determine the cause, prime the motor by removing the spark plug and pour a half teaspoonful of gasoline into the spark plug opening. Replace the spark plug and crank the motor. If it fires for three or four revolutions and stops, the difficulty is definitely in the fuel system. See paragraphs 83, 86 to 89. If motor will not fire at all, check the ignition system, see paragraphs 92 to 105; also compression, paragraphs 105 to 115.

86. TO ADJUST THE CARBURETOR. The carburetor on this motor is of the gravity type. The gasoline supply is regulated by a needle valve. The throttle is automatically controlled by the governor, see paragraphs 90 and 91.

87. To adjust the carburetor, completely close needle valve by turning to right or clockwise as far as possible. Do not screw up too tight or use force when closing needle valve, or needle valve may be damaged. From closed position, open needle valve one-half to three-quarter turn. After the motor has been started and warmed up make final adjustment with the choke wide open

Carburetor and Governor Hook-up
Plate No. 9

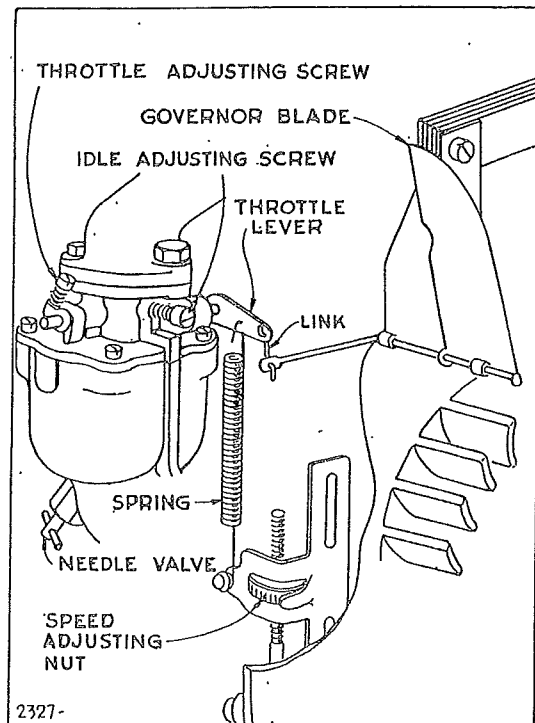

by turning the needle valve to the point at which motor operates most smoothly with full load. This setting will also take care of starting with use of the choke. When starting cold motor, if it is necessary to keep choke partially closed several minutes before motor runs smoothly, carburetor setting is too lean and needle valve should be opened a notch or two—turn to left. For governor adjustments see paragraphs 90 and 91. The idle adjustment screw setting is about a half to three quarters of a turn open. Do not force screw against seat or you will damage both. See plate No. 9. The throttle lever adjustment screw is set at the factory to permit an idling speed of about 1600 R.P.M. We do not recommend adjusting the throttle to bring the speed lower. If you want to idle the motor at a higher speed than 1600 R.P.M. turn the throttle lever adjusting screw to the right or in a clockwise direction.

88. TO REMOVE AND REPLACE CARBURETOR. Close shut-off valve on top of gas tank, disconnect gasoline line from gas

filter, loosen air cleaner elbow and carburetor. Remove air cleaner and elbow, unhook throttle and control return spring, loosen carburetor and unhook throttle link. To replace, reverse the operations as performed above.

89. TO CLEAN CARBURETOR. Remove it from the motor as explained in the previous paragraph. Remove gas line connector elbow. To disassemble carburetor, FIRST remove needle valve, stuffing box nut, packing nut gland and nozzle. Then remove screws and lockwashers from the upper carburetor body. CAUTION: The upper and lower bodies are interlocked by the nozzle and failure to disassemble in above order will result in damaged parts. To check inlet valve and seat, pull out brass pin holding carburetor float. A worn or dirty inlet valve and seat or incorrect float level will cause carburetor to leak. In reassembling, float should be in a horizontal position when it closes inlet valve and seat. To check float, invert upper carburetor body and place a scale or a flat, straight piece of steel across carburetor float and see that distance from top of float to carburetor body flange is equal at both sides of float. See plate No. 10. The float hinge tang can be bent to attain proper position of float. If any parts are gummy, clean them in alcohol or acetone. Blow through all passages and openings. Do not use wire to clean out small holes. Replace worn or damaged parts.

Carburetor Float Position — Plate No. 10

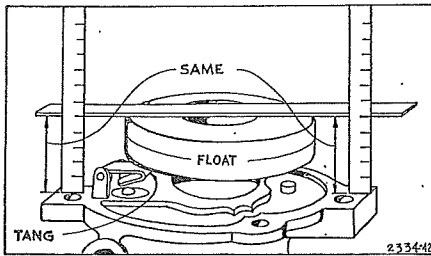

90. GOVERNOR — CORRECT MOTOR SPEED. The speed of your motor is automatically maintained under varying loads by a pneumatic governor. It is operated by the air current blown by the flywheel. The governor was carefully adjusted at the factory to maintain normal speed under load. Do not re-adjust unless absolutely necessary. Recommended speed is 2900 R.P.M.

91. GOVERNOR SPEED ADJUSTMENT. A thumb nut speed adjuster is located beneath carburetor. Turning the nut down or counter-clockwise increases motor speed; up or clockwise decreases motor speed.

92. THE IGNITION SYSTEM. The spark is produced by a high tension magneto consisting of armature, condenser, contact points and rotating magnets cast in the flywheel. This is a simple self-contained system which is very reliable. It also does away with batteries. The ignition current is sent into the motor cylinder through the ignition cable and spark plug. The magneto itself as well as the cable and spark plug must all be in proper condition and adjustment to insure a good hot spark.

93. TO CHECK FOR SPARK. To prove that a satisfactory spark is being delivered by the magneto, remove the ignition cable from the plug. Hold ignition cable terminal about 1/8" from any metal part of the cylinder head (keep hand on insulated part of the cable to avoid a shock). Turn motor with starter, and if the spark jumps this gap the entire ignition system, with the exception of the spark plug, is O.K. See plate No. 11. (To check spark plug see paragraph 94.) If no spark, check cable, see paragraph 95, and refer to magneto adjustments, paragraphs 96 to 104.

94. SPARK PLUG ADJUSTMENT. Spark plugs should be cleaned and points reset to .025" after each 100 hours of operation. See plate No. 12. Points burn away in service. The porcelain is to prevent the spark from jumping anywhere except at the gap, and if cracked or broken it will prevent the plug firing. Water on the outside of the spark plug may permit the high voltage current to leak over the surface of the porcelain. Dirt or carbon on it will do the same thing. The spark plug can be cleaned by washing off the carbon with gasoline or kitchen scouring powder. Points should be scraped or sandpapered. See plate No. 12. Always keep a new plug on hand. We recommend the use of Champion No. J8, or its exact equivalent.

When reassembling spark plug to cylinder head put a little graphite grease on threads. Do not get grease on points.

Checking Spark
Plate No. 11

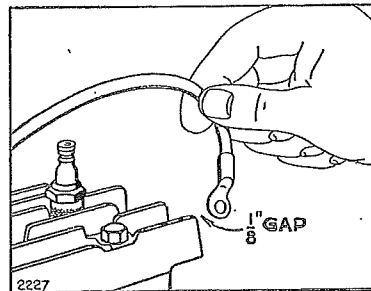

Spark Plug
Plate No. 12

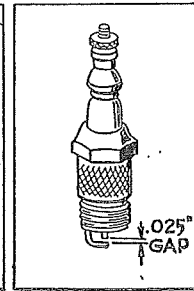

95. IGNITION CABLE. Insulation must not be broken or soaked with oil or water or grounded in any way where it touches the motor, or it will interfere with good ignition. To check cable all the way to magneto it is necessary to remove blower housing. Ignition cable should be securely wound to the secondary terminal loop of the coil. See plate No. 16.

96. TO REMOVE AND REPLACE FLYWHEEL. The flywheel is securely mounted to the crankshaft by means of a taper fit, a key, a LEFT hand nut and a spring washer. Remove the blower housing. Bolt or clamp motor to work bench. Place a wood block under flywheel fin on right side of flywheel or a small rod between fins, to hold it rigid and prevent turning as you loosen nut. See plate No. 13. Use large wrench, 10-inch or bigger. To start nut, to the RIGHT, tap end of wrench handle lightly with hammer. Tap carefully or a broken fin may result which will throw flywheel out of balance. After nut is removed, loosen flywheel by placing the wood block against end of crankshaft and striking with a hammer. Pull off flywheel.

Removing Flywheel
Plate No. 13

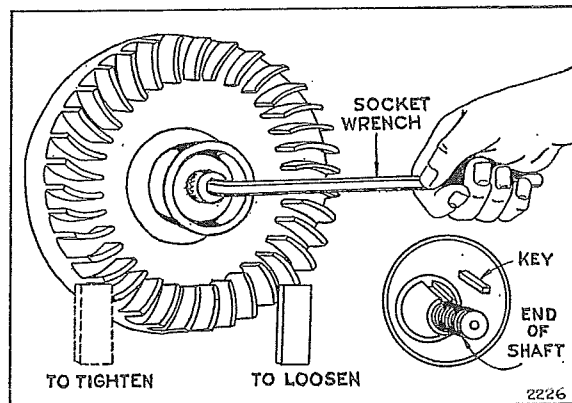

87. To reassemble, locate flywheel on crankshaft with key and install spring washer with the hollow or concave side next to the flywheel. Turn nut to LEFT until tight. Then use block under fin on left side of flywheel or rod between fins to hold flywheel rigid and draw nut up very tight by tapping wrench handle with hammer.

88. TO REMOVE AND REPLACE MAGNETO ASSEMBLY. After removing the flywheel as explained in paragraph 96, remove magneto point dust cover. If carburetor has not been removed, it is not necessary to do so. Remove governor air vane from armature. Unhook governor spring from speed adjusting slide plate. Detach ignition cable from spark plug. Remove four magneto plate mounting screws. To replace, use same gasket between the plate and crankcase, or if damaged, a new gasket, see part numbers 67307, 67597, 67607, of proper thickness to get correct end play of .002" to .008" between magneto bearing and crankshaft thrust faces, as shown in plate No. 14. Use lockwashers under mounting screws.

89. MAGNETO TIMING. Magneto assembly is always correctly timed with the motor when the flywheel is assembled to the tapered crankshaft with a key and securely held in place with LEFT hand threaded nut. Do not attempt to change the timing by locating any parts or filing crankshaft timing flat. Always use soft key part No. 61760—if steel key is used and flywheel becomes loose, it will damage the keyway in the crankshaft.

Correct End Play
Plate No. 14

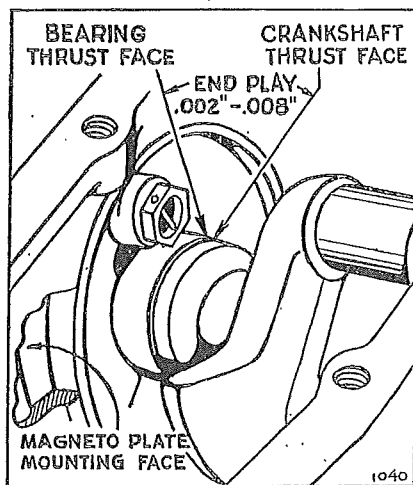

100. TO ADJUST AND CLEAN CONTACT POINTS. Remove blower housing, flywheel and magneto point dust cover. Turn crankshaft by hand to see if contact points open and close properly. Points must be clean and line up squarely to make good electrical contact. Do not use steel file. Use carborundum contact point file. Adjust gap to .020" by loosening the adjusting lock screw and moving contact point bracket up or down. When proper gap is obtained tighten lock screw securely. If either or both points become badly pitted or burned and need replacement, always order complete assembly Part No. 29667.

101. TO REPLACE CONDENSER. A leaky or weak condenser may cause the motor to start hard, to sputter or misfire under load. If motor misfires after checking gasoline line, carburetor, spark plug, cable and contact points, install a new condenser. Both the condenser lead and armature lead must be soldered to brass arm, see plate No. 15. Be sure to push condenser lead down between condenser and hub of magneto plate so it cannot rub against flywheel.

Contact Points and Condenser
Plate No. 15

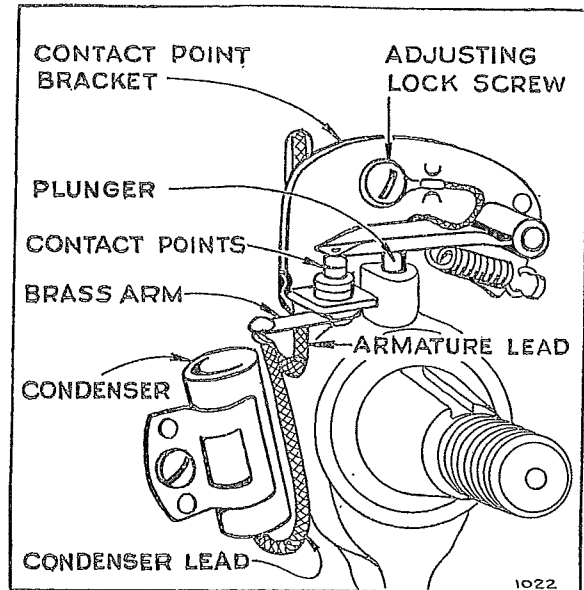

102. If after new condenser has been installed the ignition system does not deliver a satisfactory spark, we recommend checking the complete magneto and the flywheel.

103. TO REPLACE AND ADJUST ARMATURE. Remove primary armature lead wire of coil from brass arm on contact bracket. Remove high tension ignition cable from secondary terminal loop in coil. Unscrew four armature mounting screws. After installing new armature be sure that condenser lead wire and armature lead wire from coil are soldered to brass arm on contact bracket. See plates Nos. 15 and 16. Replace mounting screws, inserting loop of ground wires under screw and draw screws up tight.

104. Air gap of .008" to .012" must be maintained between armature core ends and flywheel. Gap must only be sufficient to prevent rubbing but not over .012", or poor ignition will result. To adjust gap to proper clearance, loosen the four armature mounting screws, slide armature assembly up and place correct

Complete Magneto Assembly
Plate No. 16

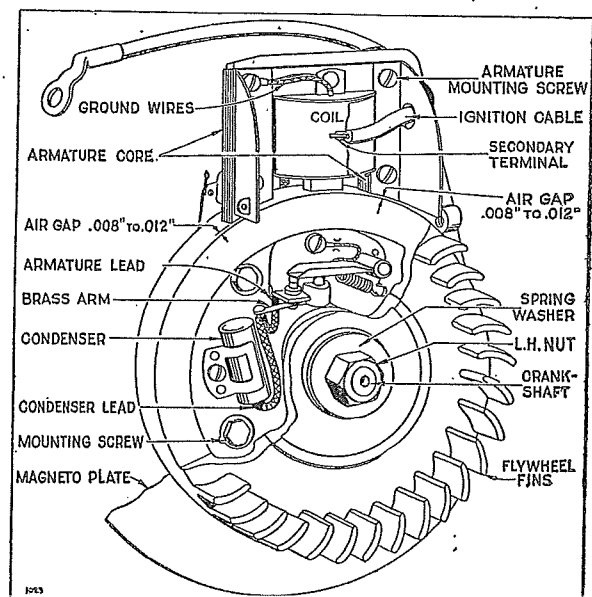

feeler gauge or 3 thicknesses of newspaper between rim of fly-wheel and armature core ends. Lower armature assembly until core ends rest on gauge or paper and tighten mounting screws securely. See plate No. 16.

105. CYLINDER HEAD. The cylinder head is held on with six cap screws. When the cylinder head has been removed for the purpose of cleaning carbon or grinding valves, care should be used in replacing it. Use a new gasket if possible. Otherwise, clean the old one and coat both sides with cup grease. We do not recommend the use of shellac on cylinder head gaskets. Tighten each cap screw a little at a time so that the cylinder head is pulled down evenly. Screws need be only moderately tight.

106. COMPRESSION. Proper compression is obtained when valves seat properly, gaskets do not leak, and piston and rings are properly fitted. When tuning up a motor, it is always well to check compression. This is done by turning the motor over quickly by hand. If turned slowly sticky valves may not be detected. If a point of resistance is offered every other revolution, compression should be satisfactory. If motor turns over without compression resistance for a full cycle, it is possible that a worn piston or piston rings, leaky valves or leaky gaskets are present. See that spark plug has a gasket under it and is drawn up tight. Also check cylinder head gasket and tighten cylinder head bolts.

107. VALVE ADJUSTMENT. To check valve clearance remove valve cover plate on cylinder below carburetor. The correct clearance on the exhaust valve is .007" to .009" and on the intake valve .005" to .007" when the motor is cold. Tappet clearance is adjusted by grinding required amount from the end of valve stem. End of stem must be square with the stem proper.

108. To remove the valves, remove cylinder head and, if not dismantled, drain oil from crankcase. Invert cylinder. Compress the valve spring with a screw driver and pull out valve retainer pin with long nose pliers. Tilt cylinder back far enough to allow valve to drop, permitting its stem to clear the spring. Pry the spring out with screw driver. To replace, reverse the operations as performed above.

109. To resseat valves, grind in same manner as automobile valves. If valves stick they may be coated with gum or carbon. To remove gum use alcohol or acetone. Clean valve stems thoroughly with wire brush or emery cloth. Also scrape all carbon from valve ports.

110. The timing of the valves is taken care of by the meshing of the cam gear with the gear on the crankshaft. These gears are properly meshed when the mark on the camshaft gear is in line with the mark on the crankshaft collar. See plate No. 17.

Valve Timing — Plate No. 17

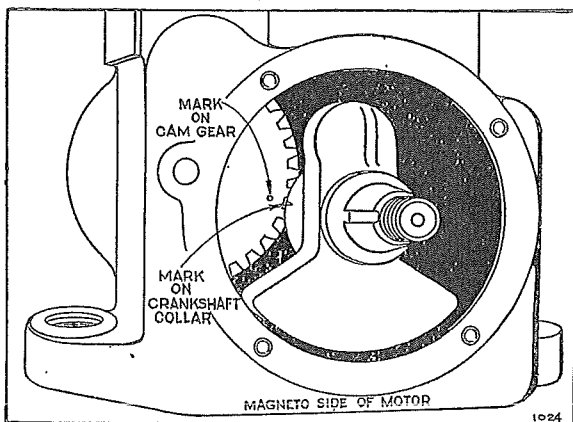

111. CRANKSHAFT. To remove crankshaft, first remove cam shaft holding the cam gear in crankcase. The cam shaft is assembled with a slip fit on magneto side of motor and a press fit on drive side. Drive cam shaft out of crankcase with a $\frac{5}{16}$ " rod or punch from the drive side. Be careful not to lose the cam shaft plug No. 68122. After cam shaft has been removed, tip motor toward carburetor side so that cam gear drops into crankcase recess to allow ball bearing to pass cam gear. To reassemble, reverse the operation.

112. PISTON. The piston in the model "T" motor is made of a special aluminum alloy which is very light in weight. The standard clearance between the piston skirt and cylinder wall is .005" to .0065". The top and second lands of the piston are smaller than the skirt to allow for greater expansion at the piston head. This clearance is to compensate for the considerable expansion of aluminum when hot. When piston is removed, be sure to thoroughly clean carbon from head of piston and ring grooves. If piston is out of round or scored, it should be replaced.

113. When fitting a new piston in the motor, assemble it with the free side pin hole (indicated with an "X" on boss) toward the magneto side. If an oversize piston is necessary, we recommend reborring of cylinder.

114. PISTON RINGS. The piston rings when fitted in the cylinder should have a gap from .007" to .015". The rings should be fitted in the cylinder below the piston ring travel. Before assembling new rings to piston be sure that piston ring grooves are thoroughly cleaned, and rings fit free in the grooves.

115. PISTON PIN. The piston pin is a slip fit in the piston. To remove it from the piston, first remove lock rings, then slip pin out of piston.

Connecting Rod — Plate No. 18

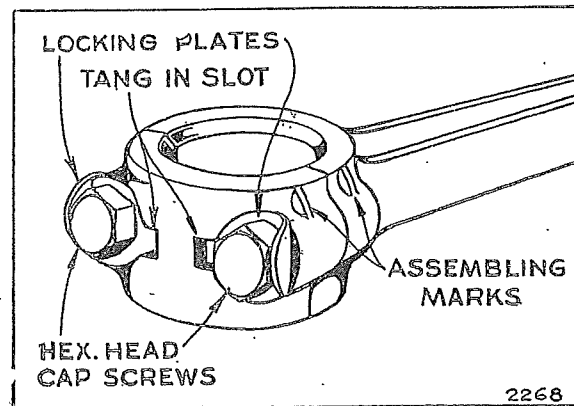

116. CONNECTING ROD. The connecting rod is also made of a special aluminum alloy which combines strength with light weight. When assembling connecting rod to crankshaft, assembly marks on cap and rod must be on the same side. These marks must also be toward magneto side of motor. Bend locking plates against hexagon head of cap screw. See plate No. 18.

117. OIL PUMP. The oil pump is assembled to the base. An inoperative pump will result in insufficient lubrication which may score the cylinder and piston assembly. To check oil pump, remove from base. Place pump in a pan of oil about $\frac{1}{2}$ " deep. Work plunger up and down. If oil is sprayed out, oil pump is in good working condition. If clogged, submerge complete unit in gasoline or kerosene for three or four hours to loosen accumulated sludge or gum. If still inoperative it should be replaced. In assembling, be sure that spring and plunger are in place. See plate No. 19.

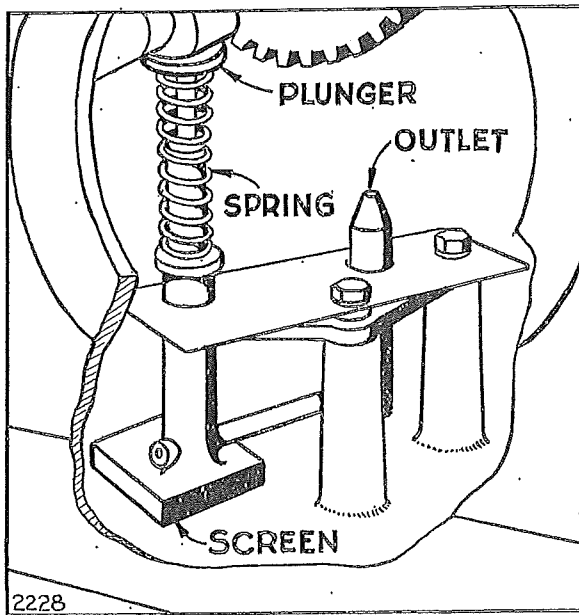

118. **CARBON.** Excessive carbon is caused by improper grade of oil—too much oil, usually the result of piston rings not seating properly or sticking—carburetor set too rich—or long service. An unusual amount of carbon is noticeable by motor knocking or loss of power. Occasionally remove carbon from piston head, cylinder head and top of cylinder bore.

119. **MUFFLER.** After long periods of service it is possible that the muffler will become clogged and reduce motor power. To check the muffler run water into the open end. If full streams of water come out of the small holes at the opposite end it is O.K. If not, it should be replaced.

120. **OIL LEAKS.** If oil leaks from either end of crankshaft, remove base from motor. Oil return valves are screwed into crank case and magneto back plate at base of main bearings. Remove oil return valve and clean or flush with gasoline and blow out any dirt lodged under the small disc. See plate No. 14.

121. **OVERLOAD.** Always be sure that the generator is running freely. If it is not, it may cause the motor to become overloaded resulting in it overheating, losing power, or even stopping entirely.

122. **PARTS.** All parts should be ordered from Briggs & Stratton Corp. or the nearest Authorized Briggs & Stratton Service Distributor, listed on page 21.

Repair Parts

Paragraph
Always Give Type, Model and Serial Number 124
How to Make Out Parts Order.....126

	Page
Parts Illustrations.....	16 and 20
Parts List	17-19

123. To assure continued satisfactory performance, do not attempt to use substitute repair parts when overhauling or repairing the Briggs & Stratton Motor. Insist that all repair parts be original Briggs & Stratton parts.

124. **ALWAYS GIVE TYPE, MODEL, AND SERIAL NUMBERS.** Briggs & Stratton motors are identified by a type number, model letter and a serial number. This information is stamped on a metal plate attached to the blower housing.

125. When writing to the factory or to a Central Service Distributor for service information, or when ordering new parts, be sure to specify the type number, the model, and the serial number of the motor to be serviced. This will assure prompt and efficient service without unnecessary correspondence.

126. **HOW TO MAKE OUT PARTS ORDERS.** Print your name and address plainly and correctly. Do not abbreviate name of town or state. Specify on the order how shipment to you is to be made. This will assist in giving prompt and efficient service.

127. Give part number and name of parts wanted. (Do not use number cast on parts.) You will find the part number, names and prices on pages 17 to 19, and parts illustrations on pages 16 and 20.

128. After you have made out order, check back to see that you have followed all directions and have accurately listed what you want.

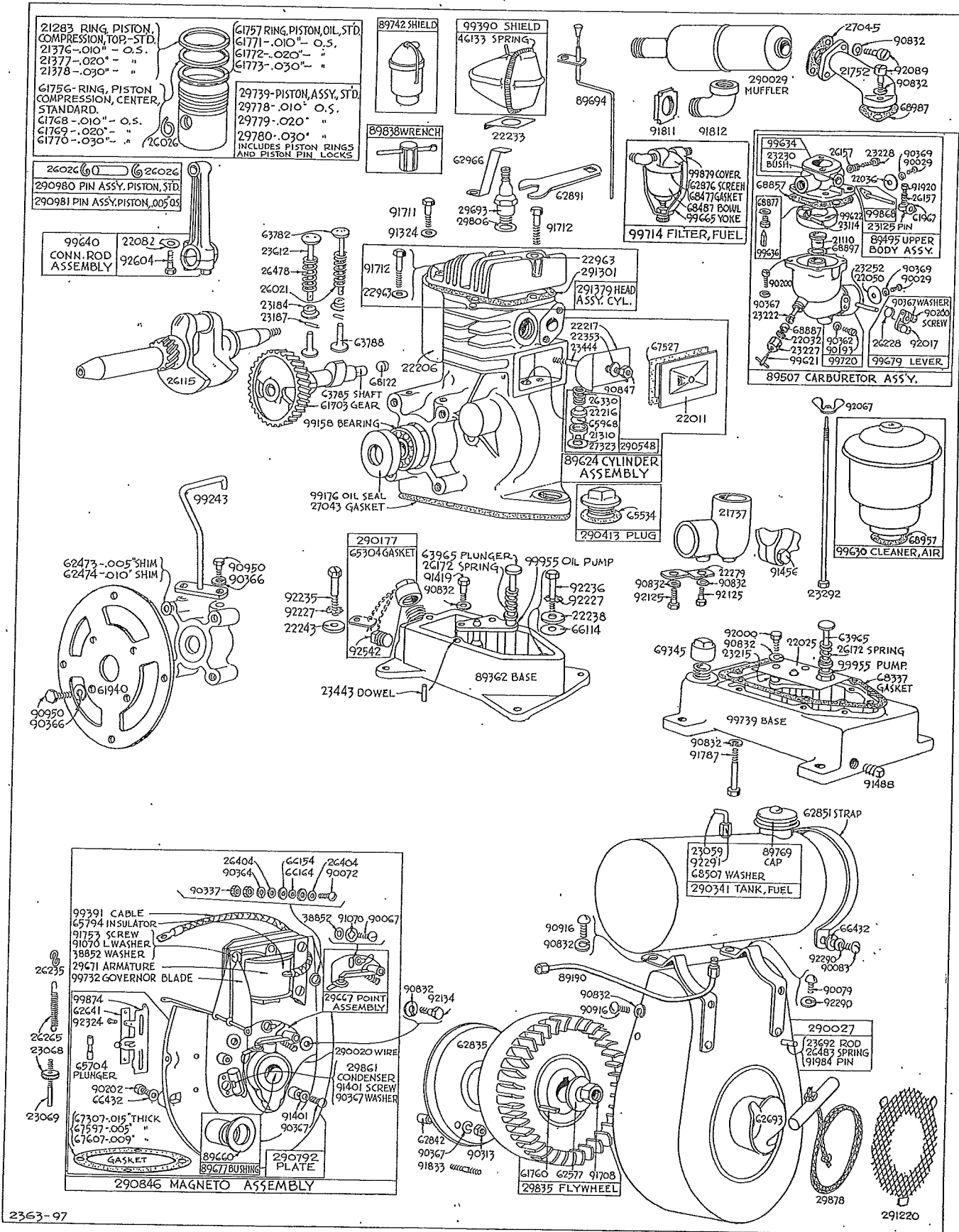

2363-97

Assemblies Include All Parts Shown In Brackets

SEE PAGE 20 FOR GENERATOR PARTS

TO FIND THE CORRECT NUMBER OF THE PART YOU NEED

1. Make a note of your motor TYPE NUMBER (Not the Serial Number) that appears on the metal nameplate attached to motor blower housing.
2. Refer to pages illustrating parts and locate the Master Part Number by comparing your old part with the illustrations. Assemblies include all part numbers bracketed in illustrations. All parts shown in assembly brackets on which part numbers are given can be purchased separately.
3. After the Master Part Number has been identified, refer to the following Parts Lists where these Master Part Numbers are listed in numerical order.

The Master Part is used on all models of motors except those types listed under "Note."
4. If a "Note" appears below the Master Part Number, this means that this part is made different from the Master Part for certain types and if your type is listed under "Note," order the part referred to.
5. If your Motor Type Number does not appear after any part number listed under "Note," order the Master Part Number.
6. When ordering parts — or writing for service information — always specify the MODEL LETTER — TYPE NUMBER — and SERIAL NUMBER of your motor.

Parts List MODEL "I" MOTOR

MASTER PART NUMBER	NAME	MASTER PART NUMBER	NAME
21110	Venturi—Carburetor	26157	Spring—Idle Valve and Throttle Adjustment
21283	Ring—Piston, Compression, Top—Standard	26172	Spring—Pump Plunger
21310	Body—Breather	26228	Spring—Choke Lever Return
21376	Ring—Piston, Compression, Top—.010" O.S.		Note: No. 26229 Spring—Choke Lever
21377	Ring—Piston, Compression, Top—.020" O.S.		Used on type Nos. 206304, 206323, 206340, 207005,
21378	Ring—Piston, Compression, Top—.030" O.S.		207009, 207012.
21737	Elbow—Air Cleaner	26235	Link—Governor
21752	Elbow—Carburetor Intake	26265	Spring—Governor
22011	Cover—Valve	26330	Spring—Breather Retainer
22025	Plate—Oil Baffle	26404	Washer—Stop Switch
22032	Washer—Needle Valve Packing	26478	Spring—Exhaust Valve
22036	Valve—Throttle	26483	Spring—Stop Switch
22050	Valve—Choke	27043	Gasket—Engine Base
22082	Lock—Connecting Rod Screw	27045	Gasket—Intake Elbow
22206	Shield—Cylinder	27323	Gasket—Breather Body
22216	Cover—Breather	29667	Point Assembly—Contact
22217	Shield—Oil Spray	29671	Armature—Magneto
22233	Plate—Spark Plug Shield Support	29693	Plug—Spark (with Gasket)
22238	Washer—Cylinder Mounting	29739	Piston Assembly—Standard
22243	Washer—Cylinder Mounting	29778	Piston Assembly—.010" O.S.
22279	Brace—Carburetor	29779	Piston Assembly—.020" O.S.
22353	Washer—Valve Cover	29780	Piston Assembly—.030" O.S.
22963	Washer—Cylinder Head	29806	Gasket—Spark Plug
23059	Lever—Fuel Shut Off	29835	Flywheel—Magneto
23068	Nut—Speed Adjusting	29861	Condenser
23069	Screw—Speed Adjusting	29878	Rope Starter
23114	Pin—Float Hinge	38852	Washer—Armature and Contact Bracket Mounting
23125	Pin—Throttle Stop	46133	Spring—Spark Plug Shield
23184	Retainer—Valve Spring	61703	Gear—Cam
23187	Pin—Valve Spring Retainer	61756	Ring—Piston, Compression, Center—Standard
23215	Spacer—Oil Baffle Plate	61757	Ring—Piston, Oil—Standard
23222	Nozzle—Carburetor	61760	Key—Flywheel
23227	Nut—Needle Valve Packing	61768	Ring—Piston, Compression, Center—.010" O.S.
23228	Valve—Carburetor Idle	61769	Ring—Piston, Compression, Center—.020" O.S.
23230	Bushing—Throttle Shaft	61770	Ring—Piston, Compression, Center—.030" O.S.
23252	Shaft—Choke	61771	Ring—Piston, Oil—.010" O.S.
	Note: No. 99700 Shaft and Lever—Choke	61772	Ring—Piston, Oil—.020" O.S.
	Used on type Nos. 206304, 206323, 206340, 207005,	61773	Ring—Piston, Oil—.030" O.S.
	207009, 207012.	61940	Plate—Generator End
23292	Bolt—Air Cleaner	61967	Stop—Throttle Lever
23443	Pin—Dowel	62473	Shim—.005" Thick
23444	Stud—Valve Cover	62474	Shim—.010" Thick
23612	Valve—Exhaust	62577	Washer—Flywheel
23692	Push Rod—Stop Switch	62641	Plate—Speed Adjuster Retainer
26021	Spring—Intake Valve	62693	Pulley—Rope Starter
26026	Lock—Piston Pin	62835	Cover—Dust
26115	Crankshaft	62842	Spacer—Dust Cover

MASTER PART NUMBER	NAME
62851	Strap—Fuel Tank
62863	Washer—Cylinder Head
62876	Screen—Fuel Filter
62891	Wrench—Spark Plug
62966	Switch—Stop
63782	Valve—Intake
63785	Shaft—Cam
63788	Tappet—Valve
63965	Plunger—Oil Pump
65304	Gasket—Oil Filler Cap
65534	Gasket—Oil Filler Cap
65704	Plunger—Contact Point
65794	Insulator—Armature
65968	Disc—Breather
66114	Washer—Cylinder Mounting
66154	Washer—Stop Switch— $\frac{1}{16}$ " Thick
66164	Washer—Stop Switch— $\frac{3}{32}$ " Thick
66432	Washer—Speed Adjuster and Tank Band Mounting
67307	Gasket—Magneto Plate—.015" Thick
67527	Gasket—Valve Cover
67597	Gasket—Magneto Plate—.005" Thick
67607	Gasket—Magneto Plate—.009" Thick
68122	Plug—Camshaft
68337	Gasket—Engine Base
68477	Gasket—Fuel Filter Bowl
68487	Bowl—Fuel Filter
68507	Washer—Shut Off Valve Packing
68857	Gasket—Carburetor Body
68877	Gasket—Fuel Inlet Valve Seat
68887	Packing—Needle Valve
68897	Gasket—Carburetor Venturi
68957	Gasket—Air Cleaner Mounting
68987	Gasket—Carburetor Mounting
69345	Cap—Oil Filler
89190	Pipe—Fuel—13" Long Note: No. 89226 Pipe—Fuel—11½" Long Used on type Nos. 206323, 207009.
89362	Base—Engine
89495	Body Assembly—Upper Carburetor Note: Used on engines after Serial No. 69735. No. 89735 Body Assembly—Upper Carburetor Used on engines before Serial No. 69735.
89507	Carburetor Assembly Note: No. 99876 Carburetor Assembly Used on type Nos. 206304, 206323, 206340, 207005, 207009, 207012.
89624	Cylinder Assembly Note: No. 99727 Cylinder Assembly Used on earlier model engines using eight screws to mount cylinder to base.
89660	Seal—Oil Note: Used on engines after Serial No. 55000. No. 23495 Ring—Oil Retainer Used on engines before Serial No. 55000.
89677	Bushing—Magneto Note: Used on engines after Serial No. 55000. No. 89340 Bushing—Cylinder Used on engines before Serial No. 55000.
89694	Rod Assembly—Choke
89742	Shield—Spark Plug
89769	Cap—Fuel Tank Note: No. 69221 Cap—Fuel Tank Used on type Nos. 206304, 206323, 206340, 207005, 207009, 207012, 207033, 207034.
89838	Wrench—Spark Plug
90029	Screw—Machine, Rd. Hd.—4-36x¼"
90066	Screw—Machine, Rd. Hd.—8-32x¼"
90067	Screw—Machine, Rd. Hd.—8-32x $\frac{5}{16}$ "
90072	Screw—Machine, Rd. Hd.—8-32x $\frac{3}{8}$ "
90079	Screw—Machine, Rd. Hd.—10-32x $\frac{3}{8}$ "
90083	Screw—Machine, Rd. Hd.—10-32x $\frac{5}{8}$ "
90193	Screw—Machine, Fill. Hd.—6-32x $\frac{3}{8}$ " Note: No. 23270 Screw—Choke Lever Used on type Nos. 206304, 206323, 206340, 207005, 207009, 207012.
90200	Screw—Machine, Fill. Hd.—8-32x½"

MASTER PART NUMBER	NAME
90202	Screw—Machine, Fill. Hd.—10-32x½"
90313	Nut—Hex.—8-32
90337	Nut—Hex.—8-32 (Brass)
90362	Lockwasher—No. 6x $\frac{3}{8}$ x $\frac{1}{2}$ " Note: No. 22062 Washer—Choke Lever Used on type Nos. 206304, 206323, 206340, 207005, 207009, 207012.
90364	Lockwasher—No. 8x $\frac{3}{8}$ x $\frac{1}{2}$ "
90366	Lockwasher— $\frac{5}{16}$ x $\frac{1}{8}$ x $\frac{1}{8}$ "
90367	Lockwasher—No. 8x $\frac{3}{4}$ x $\frac{1}{2}$ "
90369	Lockwasher—No. 4x $\frac{3}{8}$ x $\frac{1}{2}$ "
90832	Lockwasher— $\frac{1}{4}$ x $\frac{3}{8}$ x $\frac{5}{16}$ "
90847	Nut—Hex.—¼-28
90916	Screw—Machine, Rd. Hd.—¼-20x½"
90950	Screw—Cap, Hex. Hd.— $\frac{5}{16}$ -24x¼"
91070	Lockwasher—Shakeproof No. 1208
91324	Washer—¼" Standard
91401	Screw—Machine, Fill. Hd.—8-32x¼"
91419	Screw—Cap, Hex. Hd.—¼-20x $\frac{3}{8}$ "
91456	Screw—Cap, Hex. Hd.—¼-20x1"
91488	Plug—Pipe—½" Sq. Hd.
91708	Nut—Flywheel
91711	Screw—Cylinder Head—1" Long
91712	Screw—Cylinder Head—1¼" Long
91753	Screw—Machine, Fill. Hd.—8-32x1"
91787	Screw—Cap, Hex. Hd.—¼-28x2"
91811	Locknut—Muffler Elbow
91812	Elbow—Muffler—90° Note: No. 91810 Elbow—Muffler—45° Used on type Nos. 206304, 206323, 206340, 207005, 207009, 207012, 207033.
91833	Stud—Dust Cover
91920	Screw—Machine, Fill. Hd.—8-32x $\frac{5}{8}$ "
91984	Pin—Cotter— $\frac{1}{8}$ x½"
92000	Screw—Cap, Hex. Hd.—¼-28x1¼"
92017	Screw—Machine, Fill. Hd.—8-32x $\frac{5}{16}$ "
92067	Nut—Air Cleaner Wing
92089	Screw—Machine, Fill. Hd.—¼-20x $\frac{3}{4}$ "
92125	Screw—Cap, Hex. Hd.—¼-20x½"
92134	Screw—Magneto Mounting
92227	Lockwasher—Shakeproof No. 1120
92235	Screw—Cylinder Mounting
92236	Screw—Cylinder Mounting
92250	Lockwasher—No. 10x $\frac{1}{8}$ x $\frac{3}{8}$ "
92291	Nut—Shut-off Lever Packing
92324	Rivet—Tubular—¼x $\frac{3}{8}$ "
92542	Plug—Oil Drain
92604	Screw—Connecting Rod
99158	Bearing—Ball
99176	Seal—Oil
99243	Handle—Carrying
99390	Shield—Spark Plug
99391	Cable—Ignition Note: No. 99288 Cable—Ignition Used on type Nos. 206304, 206323, 207005, 207009.
99621	Valve—Needle
99622	Float—Carburetor
99630	Cleaner Assembly—Air
99634	Body—Upper Carburetor
99636	Valve and Seat—Fuel Inlet
99640	Rod Assembly—Connecting
99665	Yoke Assembly—Fuel Filter
99679	Lever Assembly—Choke
99714	Filter Assembly—Fuel
99720	Body—Lower Carburetor Note: No. 21129 Body—Lower Carburetor Used on type Nos. 206304, 206323, 206340, 207005, 207009, 207012.
99732	Blade Assembly—Governor
99739	Base—Engine
99868	Shaft and Lever Assembly—Throttle Note: Used on engines after Serial No. 69735. No. 89736 Shaft and Lever Assembly—Throttle Used on engines before Serial No. 69735.
99874	Adjuster—Speed
99879	Cover Assembly—Fuel Filter

Before ordering parts, read instructions top of page 17.

MASTER PART NUMBER	NAME
99955	Pump Assembly—Oil
290020	Wire—Ground
290027	Housing—Blower
	Note: No. 99309 Housing—Blower
	Used on type Nos. 206304, 206323, 206340, 207005, 207009, 207012.
290029	Muffler
	Note: No. 89966 Muffler
	Used on type Nos. 206304, 206323, 206340, 207005, 207009, 207012, 207033.
290177	Cap Assembly—Oil Filler
290341	Tank Assembly—Fuel
	Note: No. 99180 Tank Assembly—Fuel
	Used on type Nos. 206304, 206340, 207005, 207012, 207033, 207034.

MASTER PART NUMBER	NAME
	No. 99510 Tank Assembly—Fuel
	Used on type Nos. 206323, 207009.
	Includes: { No. 89615 Valve—Fuel Shut-off
	{ No. 99477 Tank—Fuel
	{ No. 99509 Pipe—Fuel
	{ No. 99511 Tee
290413	Cap—Oil Filler
290548	Breather Assembly
290792	Plate—Magneto
290846	Magneto Assembly
290980	Pin Assembly—Piston—Standard
290981	Pin Assembly—Piston—.005" O.S.
291220	Screen—Blower Housing
291301	Gasket—Cylinder Head ($\frac{1}{16}$ " Thick)
	Note: No. 67537 Cylinder Head ($\frac{1}{32}$ " Thick)
	Used with cast iron cylinder heads.
291379	Head Assembly—Cylinder

Before ordering parts, read instructions top of page 17.

Generator

Parts List

MASTER PART NUMBER	NAME
22356	Washer—Breaker Mounting
22561	Box—Control Note: No. 62889 Box—Control Used on type Nos. 25595, 25598, 25602, 25603.
26082	Staple—Brush
29759	Clamp—Battery
61945	Shell—Generator
62897	Cover—Generator End
62898	Retainer—Pole Shoe
65974	Grommet—End Cover
65984	Grommet—Control Box
85196	Breaker—Circuit
85759	Switch—Control and Starting Note: No. 80934 Switch—Starting Used on type Nos. 25595, 25598, 25602, 25603.
89963	Cover—Control Box Note: No. 29750 Cover—Control Box Used on type Nos. 25595, 25598, 25602, 25603.
90079	Screw—Machine, Rd. Hd.—10-32x $\frac{3}{8}$ "
90310	Nut—Hex. 6-32
90355	Nut—Hex.—10-32
90366	Lockwasher— $\frac{5}{16}$ x $\frac{1}{8}$ x $\frac{1}{8}$ "
90367	Lockwasher—No. 8x $\frac{5}{16}$ x $\frac{1}{2}$ "
90528	Screw—Cap, Hex. Hd.— $\frac{1}{4}$ -28x $\frac{3}{4}$ "
90596	Screw—Machine, Rd. Hd.—10-32x $\frac{7}{16}$ "

MASTER PART NUMBER	NAME
90781	Screw, Machine, Fill. Hd.—8-32x $\frac{5}{16}$ "
90832	Lockwasher— $\frac{1}{4}$ x $\frac{3}{8}$ x $\frac{3}{4}$ "
91697	Screw—Sheet Metal—No. 6x $\frac{1}{4}$ "
91719	Lockwasher—No. 6x $\frac{5}{16}$ x $\frac{3}{4}$ "
91893	Screw—Cap, Hex. Hd.— $\frac{5}{16}$ -24x2 $\frac{1}{4}$ "
91895	Screw—Cap, Hex. Hd.— $\frac{1}{4}$ -28x1"
92290	Lockwasher—No. 10x $\frac{1}{8}$ x $\frac{3}{4}$ "
92504	Screw—Machine, Rd. Hd.—6-32x $\frac{1}{4}$ "
99248	Brush and Spring—Generator
99249	Fan—Generator
99252	Brush Holder and Bracket Assembly
99255	Coil—Generator Field (Set of 4)
99256	Shoe—Generator Pole
99257	Armature—Generator
99258	Wire—Lead (Ground)
99259	Wire—Lead (Switch to Generator)
99260	Wire—Lead (Switch to Circuit Breaker)
99261	Wire—Lead (Generator Brush)
99263	Ammeter
290207	Wire—Lead (Positive and Negative)

Note: {No. 99250 Wire—Lead (Positive)
{No. 99251 Wire—Lead (Negative)
Used on type Nos. 25598, 25599, 25600, 25601, 25602, 25603.

Before ordering parts, read instructions top of page 17.

Plate No. 21

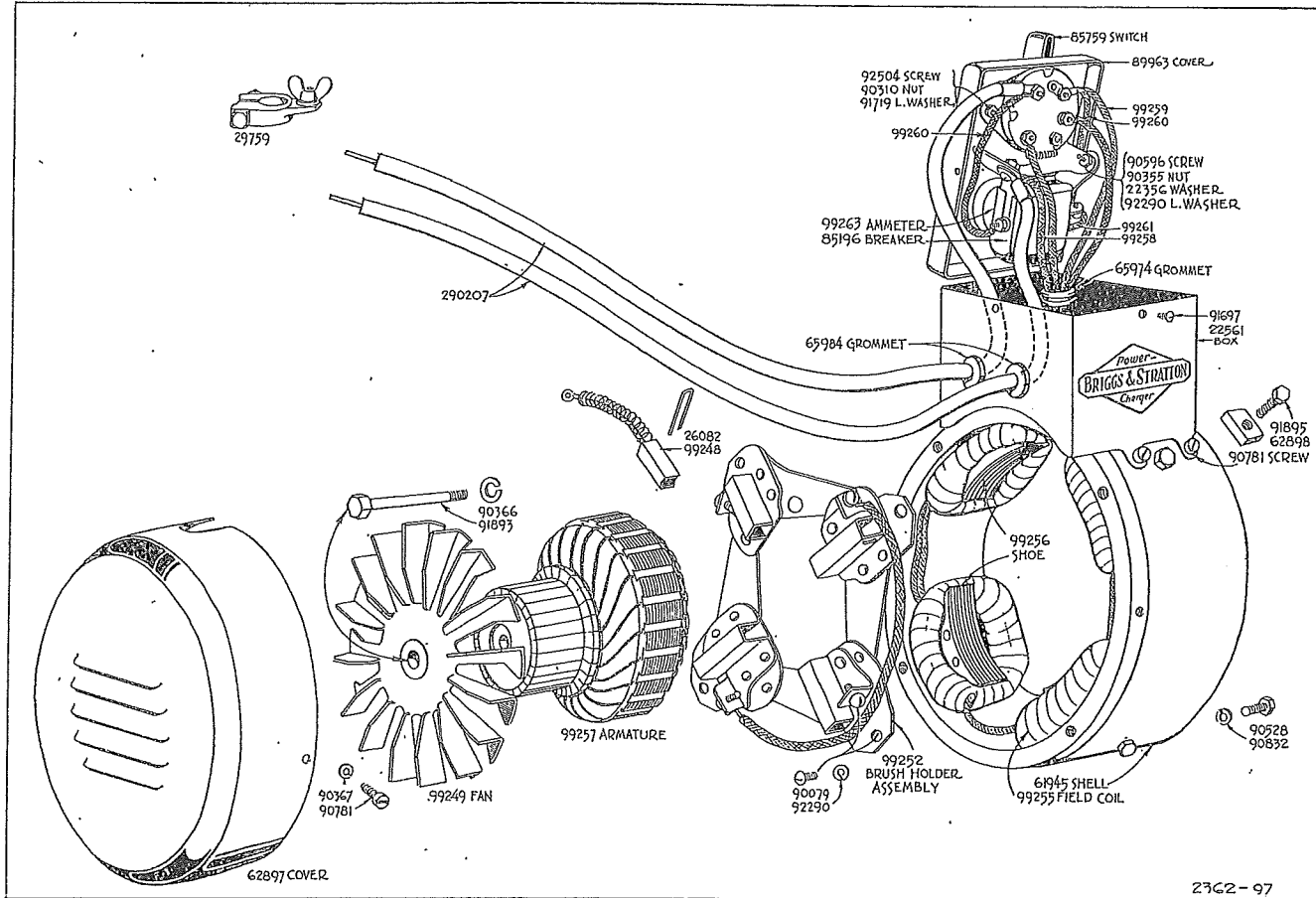

NATION-WIDE SERVICE ORGANIZATION

To provide prompt and efficient service on Briggs & Stratton motors, Authorized Central Service Distributors and Motor Service Stations are located in the principal cities of the United States and Canada.

Each Authorized Service Organization carries a complete stock of original Briggs & Stratton repair parts. Each is equipped with special factory service tools and factory-trained mechanics, assuring expert repair service on all Briggs & Stratton motors.

All Authorized Service Organizations are instructed by the factory to replace free of charge all parts found to be defective in either material or workmanship, according to the conditions of the Briggs & Stratton Guarantee.

All gratis work done under the guarantee is the responsibility of the Authorized Service Organization until all the material involved and supporting facts are submitted to and approved by the factory.

In a difference of opinion regarding a Service Organization's decision, their terms should be accepted and, either through them or direct, have all materials and supporting facts submitted to the factory for review.

Genuine Briggs & Stratton service will assure continuous motor satisfaction. Our long experience in motor maintenance prompts us to urge that all service work be done by an Authorized Service Organization or at our factory. Mechanics unfamiliar with Briggs & Stratton products, or without proper tools, should not be permitted to make major repairs.

Parts and repair work are F. O. B. Factory or any Authorized Briggs & Stratton Central Service Distributor, or Motor Service Station. The Central Service Distributor nearest you (see list below) will be glad to give you the name of our Motor Service Station in your locality. Space does not permit listing here.

Authorized Central Service Distributors

STATE	CITY	NAME	LOCATION
Alabama	Birmingham 3	Birmingham Electric Battery Co.	Ave. B. at 23rd St.
Arizona	Phoenix	Motor Supply Co.	315 N. Central Ave.
California	Los Angeles 15	Electric Equipment Co.	1611 S. Hope St.
California	San Francisco 3	Frank Edwards Co., Automotive Service Div.	382-4 Sixth St.
Colorado	Denver 1	Spitzer Electrical Company	43 W. 9th Ave.
Florida	Jacksonville 1	Spencer Electric, Inc.	40 W. Beaver St.
Florida	Miami 32	Electrical Equipment Co.	42-58 N. W. 4th St.
Florida	Tampa 1	Spencer Auto Electric, Inc.	607-11 E. Cass St.
Georgia	Atlanta 3	Auto Electric & Magneto Co.	477 Spring St., N. W.
Illinois	Chicago 16	Mid-States Auto Electric Co.	1905 S. Michigan Ave.
Indiana	Indianapolis 1	Gulling Auto Electric Co.	450 N. Capitol Ave.
Iowa	Des Moines 9	Magneto Carburetor & Electric Co., Inc.	1308 Grand Ave.
Kansas	Wichita 2	The E. S. Cowie Electric Co.	230 S. Topeka Ave.
Kentucky	Lexington 34	Kentucky Ignition Co., Incorporated	Rose and Vine Sts.
Louisiana	New Orleans 1	A. C. Suhren Company	1319 St. Charles Ave.
Louisiana	Shreveport A	Chain Battery & Automotive Supply, Inc.	Marshall at Cotton St.
Massachusetts	Boston 15	Wm. H. Flaherty Co.	48-52 Cummington St.
Michigan	Detroit 1	Auto Electric & Service Corporation	90 Selden Ave.
Minnesota	Minneapolis 2	Reinhard Brothers Co., Inc.	11 S. Ninth St.
Missouri	Kansas City 8	The E. S. Cowie Electric Co.	1819 Wyandotte St.
Missouri	St. Louis 3	Medart Auto Electric Co., Inc.	3134 Washington Blvd.
Montana	Billings	Lee Pasley	423 N. Broadway
Nebraska	Lincoln 8	Carl A. Anderson, Inc.	1637 P Street
Nebraska	Omaha 2	Carl A. Anderson, Inc.	16th and Jones Sts.
New Mexico	Albuquerque	Spitzer Electrical Co.	509 N. Second St.
New York	Buffalo 14	The Battery & Starter Co., Inc.	2505 Main St.
New York	New York 23	The Durham Co., Inc.	17 W. 60th St.
New York	Syracuse 4	The Durham Co., Inc.	943 W. Genesee St.
North Carolina	Charlotte 1	Carolina Rim & Wheel Co.	312 N. Graham St.
North Dakota	Fargo	Reinhard Brothers, Inc.	301 N. Pacific Ave.
North Dakota	Minot	Reinhard Bros. Co., Inc.	18-20 3rd St., N. E.
Ohio	Cincinnati 2	Gardner, Inc.	215 E. 8th St.
Ohio	Cleveland 15	The Electric Power Maintenance Co.	2536-40 Prospect Ave.
Ohio	Toledo 2	The Electric Power Maintenance Co.	26-30 Seventeenth St.
Oklahoma	Oklahoma City 2	American Electric Ignition Co.	124 N. W. 8th St.
Oregon	Portland 9	Tracey & Co., Inc.	N. W. 10th and Glisan
Pennsylvania	Philadelphia 30	Auto Equipment & Service Co., Inc.	1522-24 Fairmount Ave.
Pennsylvania	Pittsburgh 24	Pitt Auto Electric Company	5135 Baum Blvd.
South Dakota	Aberdeen	Reinhard Brothers Co., Inc.	317 S. Lincoln St.
South Dakota	Sioux Falls	Reinhard Bros., Inc.	225 E. 11th St.
Tennessee	Knoxville 7	R. T. Clapp Company	401-7 N. Broadway
Tennessee	Memphis 4	Automotive Electric Service Co.	982 Linden Ave.
Texas	Amarillo	The E. S. Cowie Electric Co.	700 Van Buren St.
Texas	Dallas 1	Beard & Stone Electric Co., Inc.	2101 Bryan St.
Texas	El Paso	Motor Supply Co.	308 Chihuahua St.
Texas	Houston 1	Beard & Stone Electric Company, Inc.	Milam at Polk Ave.
Texas	San Antonio 6	S. X. Callahan	425 N. Flores St.
Utah	Salt Lake 13	Frank Edwards Co., Motor Equipment Div.	605-609 So. State St.
Virginia	Richmond 20	Richmond Battery & Ign. Co.	1319 W. Broad St.
Washington	Seattle 14	Sunset Electric Co.	300 Westlake North
Washington	Spokane	Sunset Electric Co.	First and Adams
Wisconsin	Milwaukee 2	Wisconsin Magneto Co.	918 N. Broadway
DOMINION OF CANADA			
Manitoba	Winnipeg	Beattie Auto Electric Limited	176 Fort St.
Ontario	Toronto-5	Auto Electric Service Company Limited	1009-27 Bay St.

Only Authorized Service Organizations
Display this Sign —



Your Assurance of Efficient
Briggs & Stratton Service

BRIGGS & STRATTON CORP., • MILWAUKEE 1, WIS., U. S. A.

Briggs & Stratton Gasoline Motors are precision built and require **original** Briggs & Stratton replacement parts in order to obtain satisfactory results. Service that is not reliable or continuous becomes expensive at any price.

Users will find that the prices paid for **original** repair parts are well worth the investment when the service delivered is compared with that afforded by substitute parts. **Original** Briggs & Stratton repair parts can be obtained through all Authorized Central Service Distributors listed on page 21.

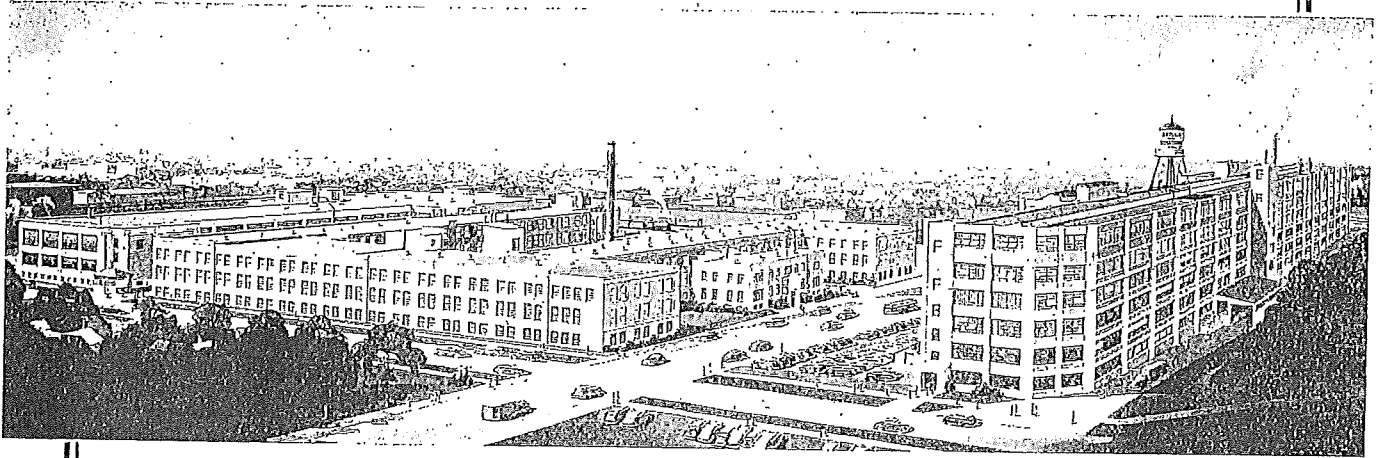

WHERE BRIGGS AND STRATTON MOTORS
ARE MADE

THESE large and modern factory buildings, located in Milwaukee, Wisconsin, are complete with all modern equipment and machinery for precision construction, economical production, rigid inspection and thorough testing of Briggs & Stratton 4-cycle gasoline motors.

Briggs & Stratton Corp. produces more small 4-cycle air-cooled gasoline motors than any other manufacturer in the world.

BRIGGS & STRATTON CORP., MILWAUKEE 1, WIS.